

Basic - Simple Weighing

Count - Simple Counting

Count Plus - Advanced Counting

Smart Plus – Superior Counting



4 Series Applications and Demonstrations

METTLER TOLEDO

4-Series Applications / Demos



- Basic – simple weighing
- Count – simple counting features
- Count+ - advanced counting features
- Smart+ - Superior counting features

4-Series Applications / Demos

Index

Multiple print templates: Smart+	4
Editing the Fixed Sample Size key – on the fly: Smart+	8
Control Mode Output – SIH: Basic, Count, Count +, Smart +	10
Coin Counting Application: Smart+	12
Count + Weigh Simultaneously: Smart+	17
Piece Count & Check the Weight: Smart+	19
Connecting a Bar Code Scanner: Smart+	22
Checking for Correct Piece Weight: Smart+	23
Setting the Supervisor Password: Basic, Count, Count+, Smart+	26
VCC (5 VDC) on Communication Port: Basic, Count, Count+, Smart+	27
High Resolution: Smart+	29
Averaging / Dynamic Weighing: Basic, Count, Count+, Smart+	32
Custom Unit: Smart+	36
USB installation: Basic, Count, Count+, Smart+	43
USB Application: Basic, Count, Count+, Smart+	50
Checkweighing / Filling with PC interface: Smart+	59
Restart: Basic, Count, Count+, Smart+	61
Checkweighing / Filling by COUNT: Smart+	63
Checkweighing / Filling by Weight or Count: Count+	69
Scale Calibration in Supervisor Access: Basic, Count, Count+, Smart+	72
Printing Multiple Labels: Smart+	74
Digital I/O: INPUT: Basic, Count, Count+, Smart+	76
Digital I/O: OUTPUT: Basic, Count, Count+, Smart+	80
Digital I/O with Relay 4: Basic, Count, Count+, Smart+	85
Using Tare Memory: Count +	88

4-Series Features

This chart shows which models have the features included in this compilation of demos. Only one of the models will have the feature demonstrated.

Application	Basic	Count	Count+	Smart+
Averaging / Dynamic Weighing	✓	✓	✓	✓
Checking for Correct Piece Weight				✓
Checkweighing / Filling by Count			✓	✓
Checkweighing / Filling by Weight			✓	✓
Checkweighing / Filling with PC Interface				✓
Coin Counting Application				✓
Connecting a Bar Code Scanner				✓
Control Mode Output – SIH	✓	✓	✓	✓
Count & Weigh Simultaneously				✓
Custom Unit				✓
Digital I/O with Relay 4	✓	✓	✓	✓
Digital I/O: INPUT	✓	✓	✓	✓
Digital I/O: Output	✓	✓	✓	✓
Editing the Fixed Sample Size Key – on the fly				✓
High Resolution Display				✓
High Resolution data Output	✓	✓	✓	✓
Multiple Print Templates				✓
Piece Count & Check the Weight				✓
Printing Multiple Labels				✓
Restart	✓	✓	✓	✓
Scale Calibration in Supervisor Access	✓	✓	✓	✓
Setting Tare Memory			✓	
Setting the Supervisor Password	✓	✓	✓	✓
USB Application	✓	✓	✓	✓
USB Installation	✓	✓	✓	✓
Vcc (5VDC) on Communication Port	✓	✓	✓	✓

Multiple print templates: Smart+

Can I have two templates, one for Receiving and one for Shipping? How complicated would it be to setup?

With 4-Series Smart+ this is indeed possible, not only with two templates, but actually five custom templates, plus the standard template for a total of 6 templates from which the operator may select.

4-Series Smart+ Concept, overview:

In the Smart Plus we have the standard template plus 5 custom templates you can use. These templates are independent functions, by that we mean they can be created/edited but not necessarily used. Once created they are available but they not used until selected.







We choose the template by selecting it in the communication port setup. Template is one of the selections in com port setup, along with baud rate, etc.

To have selectable templates on one communication port, which will have one printer attached, we provide a softkey for the operator. The operator selects the desired template through the softkeys on the keyboard.

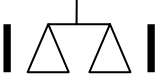
Operator sequence:

In this demo we have one printer attached to COM 1, two templates, one for SHIPPING and one for RECEIVING.





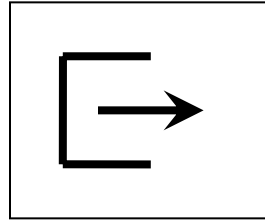

Here is a sketch of the Smart+ screen and keys.

	Smpl 10	Smpl n	APW	Unit	Template
					

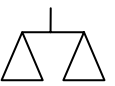







Most of the time our operator counts parts prints a ticket, using TEMPLATE 1 which we have renamed SHIP. So long as the operator continues to print shipping tickets, he simply touches the Print.









When the operator wishes to print a RECEIVING ticket, he now switches templates by first touching the Template key.

	Smpl 10	Smpl n	APW	Unit	Template
					

The Template selection screen opens. Scroll to REC template and touch the Select key.

Standard SHIP					
REC					
Template 3					
				Select	Cancel
					

Operator touches the COM 1 key to assign the REC template to COM1 (Which is where our printer is attached).

Standard SHIP					
REC					
Template 3					
Com1	Com2	Com3	Com1-3		Cancel
					

That's it! Now the printer will print the REC template when touching the print key.

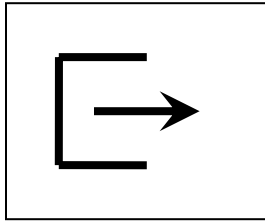







How do we setup the Smart+ to do this?

- First we create templates 1 & 2 (this topic covered elsewhere).
- Next we rename templates 1 & 2 to SHIP and REC to make the operation more intuitive for the operator. Here is how we do this.
 - In setup, go to COMMUNICATION / Define Printout / Template 1 / Name / Edit..... Key in SHIP. The template is now renamed from Template 1 to SHIP, when you go through setup, now you will find SHIP instead of Template 1, but it is still the same template.
 - Repeat the procedure to rename Template 2 to REC.
- Lastly we assign template SHIP (template 1) to COM1, this is the template automatically selected at power up.

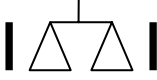
END of demo.

Editing the Fixed Sample Size key – on the fly: Smart+







The default configuration provides two softkeys for Sample size, one is “Smpl 10” for a fixed sample size of 10 pieces, and “Smpl n” for a variable sample size.

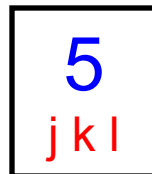





	Smpl 10	Smpl n	APW	Unit	BigDis
					

When the operator touches the “Smpl 10” key, the Smart+ determines the average piece weight based on 10 pieces. But if the customer wants to change to sampling with 5 pieces or 15 pieces for awhile, it is easier to change the “Smpl 10” key than to use the “Smpl N” key repeatedly.

To change the “Smpl 10” key to “Smpl 5” for example, the operator touches the number 5 key, then the “Smpl 10” key, the Smart+ will sample with 5 pieces and change the Smpl 10 to “Smpl 5”.



	Smpl 10	Smpl n	APW	Unit	BigDis
					

	Smpl 5	Smpl n	APW	Unit	BigDis
					

Suppose you don't want this default feature? This can be turned off in setup:

Application / Counting / Sample_x / Edit / Freeze.

Now the Sample x (Smpl 10 by default) can not be changed on the fly. To change this setting, either the Supervisor or Technician passwords are required.

END of demo.

Control Mode Output – SIH: Basic, Count, Count +, Smart +

With 4-Series scales we have access to the “control mode” weight. Control mode is expanded weight. The control mode weight can be read over the communication port by using the special SICS command included in the 4-Series products. The command is SIH and the scale responds with the current weight in expanded mode regardless of stability.

Here are some sample strings returned from the SICS commands, the scale used has a division size of 0.002 lb.

SI		[SICS command “Send Immediately” sent by the PC]
S S	2.002 lb	[Response from scale in normal display precision]
SIH		[SICS command “Send Immediately High Precision” sent by the PC]
H S	2.0011 lb	[Response from scale in high precision]

There is no SICS command for send high precision continuous.

Application example:

Customer uses a 4-Series counting scale (Count, Count + or Smart +) with second scale SICS. If the attached SICS second scale can accept the SIH command the 4-Series counting scale will use the high precision (control mode) weight instead of the display weight. For an SICS second scale used as a **reference (sample) scale** this means our sampling precision is expanded to the control mode. If the SICS second scale is used as a **bulk scale** then our count precision is based on the control mode precision. This is useful for higher count precision on a large scale like a floor scale. Let's look at an example.

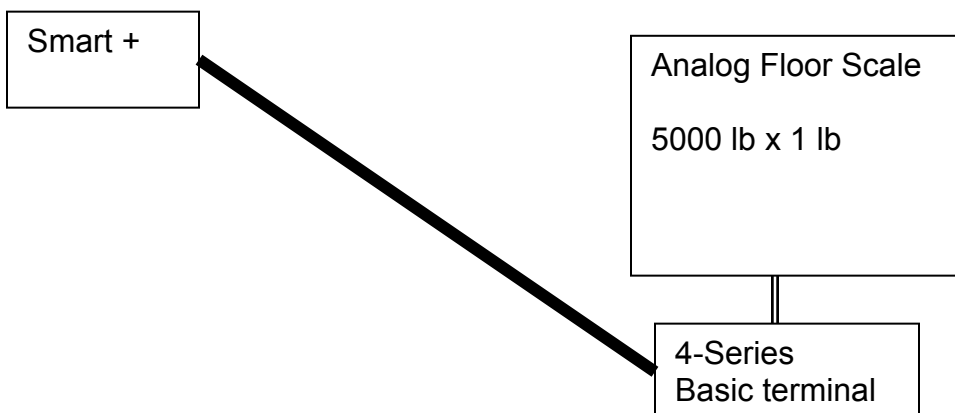

If the average piece weight (APW) of the parts is 0.05 lb and the bulk scale division size is 1 lb, the bulk count will update by 20 pieces; 10,000, 10,020, 10,040 etc.

But since we have a 4-Series terminal as the second scale the bulk count will update using control mode weight, which in our example is 20 x or 0.05 lb. So now the bulk count will update by 1 piece; 10,000, 10,001, 10,002 etc. (If our APW is .01 lb the bulk count will update by 5 pieces instead of 100 pcs for displayed weight.)

Note: The SICS second scale feature has nothing to do with analog second scale option. The analog second scale option also uses control mode weight. The SICS second scale does not replace the analog second scale, it is a feature which can be used in the case where you want a terminal on the second scale.

END of demo.

Coin Counting Application: Smart+



Coin counting is standard operation for casino gambling, banking, vending and toll collection businesses. METTLER TOLEDO has a long history of participating in this market with our two levels of coin counting scales: the hard count scales like the 9183 and change kiosk scales like the 8582 Coin Counter and the Viper Coin Counter.

With the 4-Series Smart+ we have increased product functionality and the flexibility to meet the requirements of transactional coin counting. As the successor to the Viper Coin Counter, the 4-Series "Smart+" count counter inherits the superior weighing performance of the Viper scale, some say the 4-Series weighs even better than Viper, and expands on the functionality.

METTLER TOLEDO has implemented the feature of “factor on piece”, which means we can now factor \$ dollar amount onto the piece count, instead of the weight. Along with other enhancements in the 4-Series, all setup can be done in the field. Of course, “factory”, setup to the standard Coin Count configuration can be provided for a nominal price adder so the application is ready run “out of the box”!

No More Custom Software!

The standard application setup is just the foundation, the customizing is up to you, and you have all the power and features of the 4-Series Smart+ to work with!

- Ever want to modify the printed label? – Now you can!
- Ever want Ethernet connectivity – Now you can add it!
- Ever want an ID field? – Now you can setup not just one, but three! That you define!
- Ever want more coin / token articles? – Now you can! Up to 1,500 different articles can be stored in the database!

Here are some photos of the 4-Series Coin Counter.

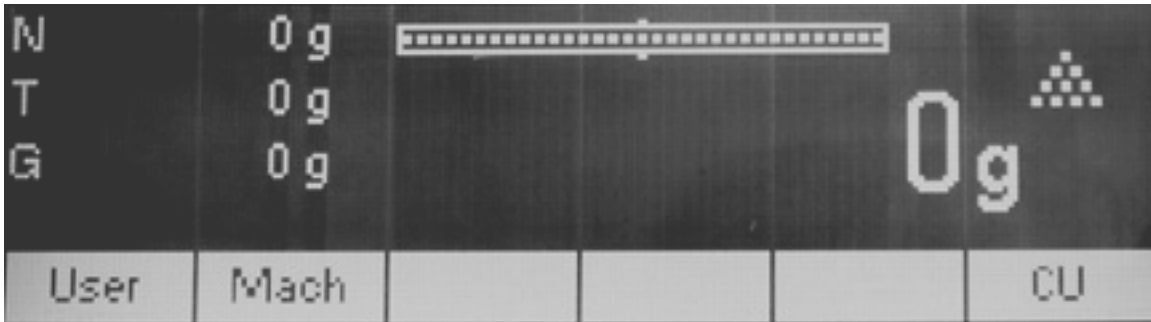
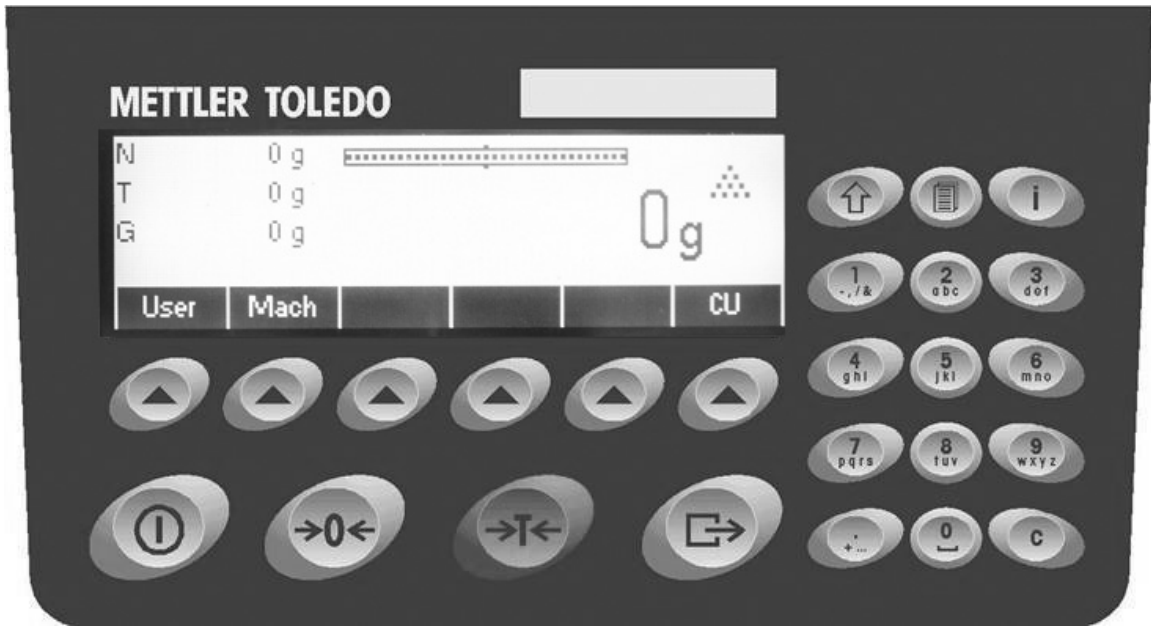

You can change User and Mach(ine) to whatever you want and even add a third ID!

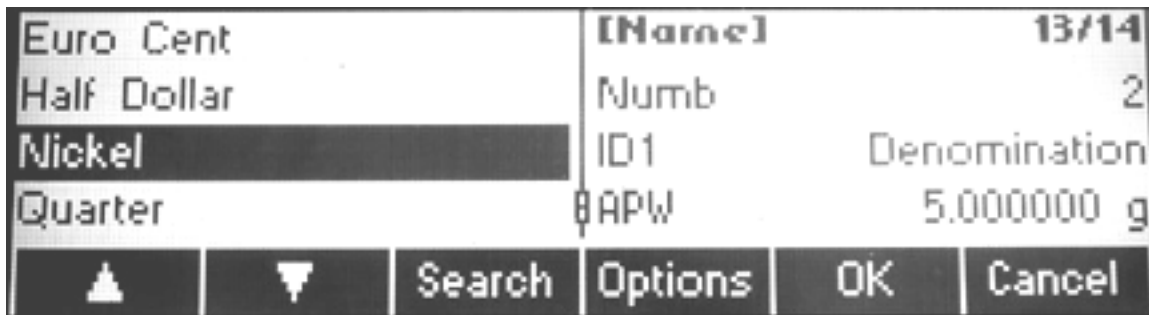

Select the coin/token denomination from the database – you can add additional denominations up to 1,500 maximum!

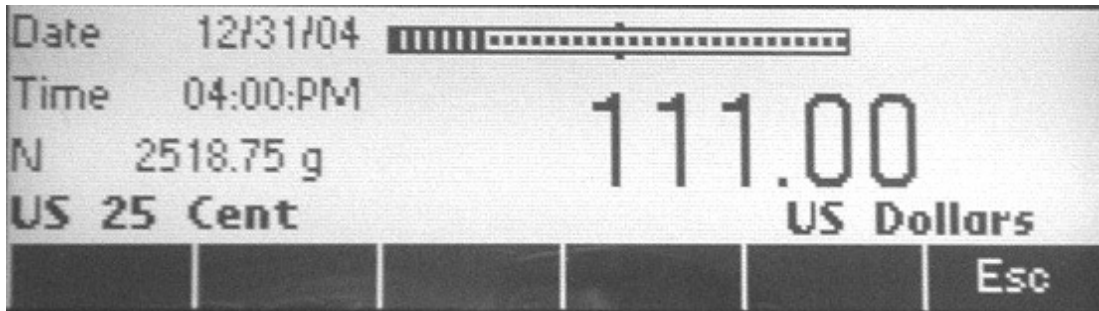

Count and Print!

METTLER TOLEDO, Inc.
 Smart Plus
 Coin Counter Application

02/18/2005 03:41:PM

User ID: Herman
 Mach ID: Slot 123ABC
 Denomination US 25 Cent
 Piece Wt 5.670 g
 Tare Wt. 150.00 g
 Net Wt. 2518.75 g

Amount 111.00 US Dollars

METTLER TOLEDO, Inc.
 Smart Plus
 Coin Counter Application

02/18/2005 03:51:PM

User ID: Herman
 Mach ID: Slot 123ABC
 Denomination 20 Euro Cent
 Piece Wt 5.740 g
 Tare Wt. 150.00 g
 Net Wt. 16050.05 g

Amount 559.20 Euro

For coin applications, you size the scale and go! For Bill counting the 4-Series application is the same, select a MonoBloc scale and create articles for the different currency notes, remember, no more than 1500 different!

The full operating instructions and setup parameters are in a separate document for the Coin Count Application. Document P/N: 17287700A

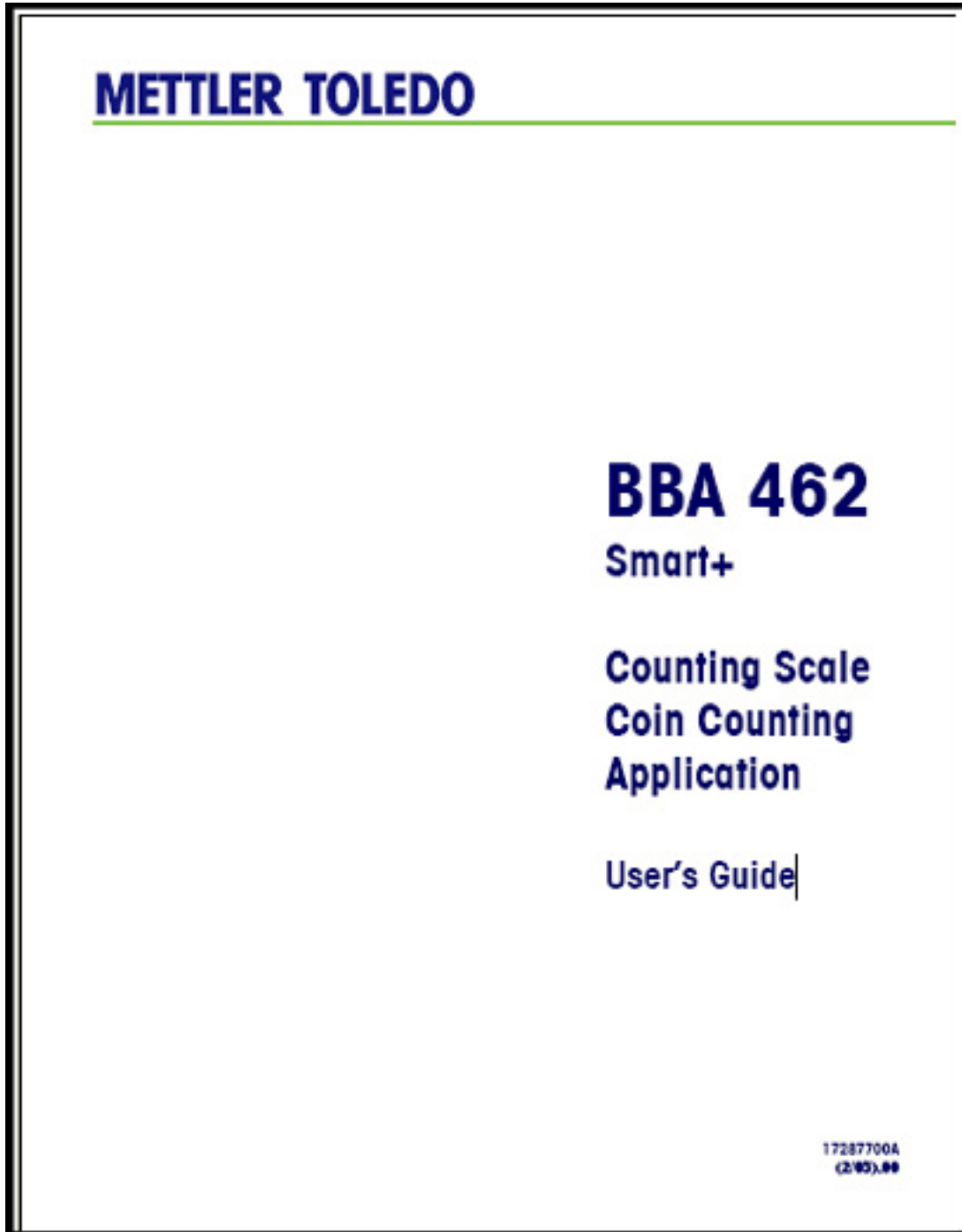





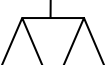

END of demo.

Count + Weigh Simultaneously: Smart+

There are applications where the customer is interested in both the Piece Count and the Weight. It is quite common for the label to include both count and weight. But what about the application where we want to count and weigh simultaneously?





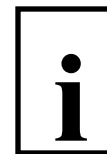

With the use of the INFO key the operator can COUNT and simultaneously view the GROSS / TARE / NET weight. The information display fields are to the left of the main display.

N 2.030 lb T 0.386 lb APW 0.014191 lb		143 PCS Net			
	Smpl 10	Smpl n	APW	Unit	BigDis
					

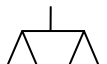
By touching the Information key, you display a customized list of variables: sample selections are Gross / Time / Date / Accuracy / Zoom / Consecutive Number.



The fourth line of the information screen has even more selections (more selections, because we have more screen space on line 4). Additional selections include ID1, ID2, ID3, Text, database size.

Time 02:17: PM Date 03/15/05 Cno 23		143 PCS Net			
	Smpl 10	Smpl n	APW	Unit	BigDis
					

To customize the information screen: Application / Info/Help / Edit / Line config. /edit / Info number / selection.







This a great solution for almost all applications.

END of demo.

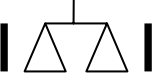





Piece Count & Check the Weight: Smart+

The application is to fill cartons by PIECE COUNT and afterwards to check weigh the carton by WEIGHT as a double check to see that not only the count is correct, but that the weight is correct which helps confirm that the correct parts were counted.

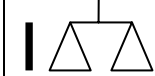
Operation.







Time 02:17: PM Date 03/15/05 G 0.330 lb		0.330 lb			
	Smpl 10	Smpl n	+/-	BigDis	
					

1. Operator places the empty container on the scale
2. Operator recalls the article ID from the Smart Plus database. This includes the TARE wt, APW and the target weight (not target count).

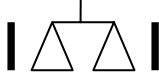





Time 02:17: PM Date 03/15/05 G 0.330 lb		0 PCS			
	Smpl 10	Smpl n	+/-	Weigh	BigDis
					

3. Scale automatically switches to COUNT mode.
4. Operator may sample with production parts whenever he wishes, or use only the stored APW from the database.

5. Operator fills the carton to the correct piece count.







Time 02:18: PM Date 03/15/05 G 2.564 lb		210 PCS net			
	Smpl 10	Smpl n	+/-	Weigh	BigDis
					

6. When ready to checkweigh the carton, the operator touches the “+/-” softkey. Scale switches to +/- Checkweighing mode.

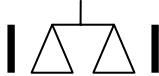





Time 02:18: PM Date 03/15/05 G 2.564 lb		GOOD		GOOD	
		OK		100.09 % Net	
	Smpl 10	Smpl n	To Zero	Accum	Esc
					

7. Operator confirms the weight is correct by viewing the +/- checkweigh delta-trac. This is a checkweigh of the weight, not the count.

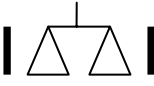
8. To piece count the next carton the operator touches the “esc” key. The Smart+ exits the +/- Checkweigh mode.

Time 02:19: PM Date 03/15/05 G 2.564 lb		2.234 lb net			
	Smpl 10	Smpl n	+/-	Count	BigDis
					

9. To return to the count mode, the operator touches the “Count” key, and proceeds with counting the next container.

Time 02:20: PM		210 PCS net			
Date 03/15/05					
G 2.564 lb					
	Smpl 10	Smpl n	+/-	Weigh	BigDis
					

Setup considerations.

- The database must have the APW for each article to be recalled and automatically begin counting.
- If stored tare is required this value must be in the article database.
- The target weight & tolerances must be in the article database.
 - For this demo we stored TARE of 0.330 lb, APW of 0.010659 lb, Checkweighing Target 2.2340 lb, - Tol 1%, + Tol 2%
- The +/- checkweighing softkey must be assigned: Application / Softkey Config / Edit / Softkey number / Edit / Checkweighing.
- The Weigh – Count softkey must be assigned: Application / Softkey Config / Edit / Softkey number / Edit / Weigh Count.

END of demo.

Connecting a Bar Code Scanner: Smart+

The Smart+ has a PS2 port for connecting a Bar Code Scanner. The scanner can be used for reading data and inputting the data into the Smart+.

With the bar code input we have two methods of inputting the data. When we have an open screen on Smart+, with the Smart+ expecting variable data, the operator can key the data in, or scan the data in. This can be used with any variable opened for data input. **This functionality works with the Smart+ out of the box**, even if the bar code assignment is set to “not used”.

The second method of inputting data with the bar code reader is to assign the bar code port to a function, in this case the bar code will automatically operate a function, or in the case of an open variable as described above, will input data to the open variable, but not the function. The bar code assignment can be selected for **ONE** of the following:

- Not Used: no function called by the bar code data.
- Article Search: Bar code input automatically searches the data base for a match with the input data. If you scan a bar code that has an article defined in the database, the Smart+ will recall the article automatically. If the article has an APW value, the Smart+ will automatically start counting.
- Tare Wt: Bar code input will preset tare. Use this for containers with known tares that have a bar code printed.
- APW: Bar code will input APW and automatically start counting (this is not associated with the database).
- ID1: Bar code will input data into the ID1 variable, DOES NOT require ID1 to be configured as a softkey.
- ID2 & ID3: same as ID1

To assign the Bar Code function, for example to Article Search: COMMUNICATION / PS2 / BCR / EDIT / select Article Search from the list.

END of demo.

Checking for Correct Piece Weight: Smart+







For the customer who samples parts when doing his counting and wants a measure of confidence that he is using the correct parts, or “good” parts, the Smart+ has the features to do this.

The Smart+ has the feature called “Piece Weight Tolerance +” and “Piece Weight Tolerance –”, with this feature we automatically test the sampled pieces against an average piece weight stored in the database.

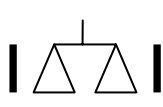
We have two general applications: checking for “good” parts, where the operator samples parts during the counting operation to make sure that the parts are not going “out of spec”. The second application is the case where the operator benefits from testing the parts that he samples to test that the sample size is correct and that the average piece weight is within tolerance.

To use the piece weight tolerances we must know the average piece weight ahead of time, this value and the respective tolerances are stored in the Smart+ database. When the operator begins to count this part, he recalls the article from the database.

Operating Sequence: illustrated with one article in the database.

N 0.000 lb T 0.000 lb G 0.000 lb		<h1>0.000 lb</h1>			
	Smpl 10	Smpl n	APW	Unit	BigDis
					

Touch the database key and select the article, nickel, from the database, then touch the OK key.



Nickel			[Name] 1/1 Numb 2 ID1 APW 0.11023 lb		
			Options	OK	Cancel
▲	▲	▲	▲	▲	▲

The article is recalled and the display shows the article name in the 4th line of the information screen. Notice that the fixed sample size softkey has changed from 10 to 5, this sample size of 5 came from the database.

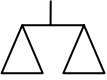
N 0.000 lb T 0.000 lb G 0.000 lb Article: Nickel		0.000 lb			
	Smpl 5	Smpl n	APW	Unit	BigDis
▲	▲	▲	▲	▲	▲

The operator places five nickels (five cent coins) on the scale, which weighs 0.054 lb, and touches the “Smpl 5” key.

If the average piece weight is within tolerance, the scale will switch to count mode.

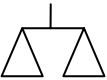
N 0.054 lb T 0.000 lb G 0.054 lb Article: Nickel		5 PCS			
	Smpl 5	Smpl n	APW	Unit	BigDis
▲	▲	▲	▲	▲	▲

If the operator places the wrong sample quantity, say six pieces, or the wrong parts, say quarters, then the Smart+ will display out of tolerance message.

N	0.066 lb	PW is out of tolerance !			
T	0.000 lb	Accept the PW anyway?			
G	0.066 lb				
Article:	Nickel				
				Yes	No
▲	▲	▲	▲	▲	▲

If the operator selects NO, the Smart will return to weight and the operator can resample. If the operator selects Yes, the Smart+ will count with sample size of 5.

The APW in the database is not changed by the operator sampling.

Setup for this application demonstration.

In the database create an article:

- Name = Nickel
- Number = 2
- APW = 0.011023 lb (or 5 grams for nickels)
- Tare = 0.0
- Sample Size = 5
- PW Tol+ = 0.000220 lb Relative (tolerance is relative to the apw)
- PW Tol- = 0.000220 lb Relative

In the vision setup no changes are required from the default configuration. The “Smpl x” softkey is required so if this has been changed you need to set it back up.

END of demo.

Setting the Supervisor Password: Basic, Count, Count+, Smart+

In this demo we will use a Smart+ scale. The factory setting for the Supervisor password is empty, which means there is no password. The user password is always empty, so in the factory configuration the User and the Supervisor passwords are the same, which means the user can enter Supervisor setup.

To create a password for the Supervisor: Terminal / Password / Edit / (key in a password, 123 for example) / touch OK / Retype password / touch OK / End & Save.

Now the Supervisor password is 123.

END demo

VCC (5 VDC) on Communication Port: Basic, Count, Count+, Smart+

The 4-Series scales and terminals can provide a Vcc of 5 VDC power connection on communication ports Com1 and Com2.

The Vcc, “Voltage Controlled Current source”, is the operating supply voltage for a circuit. In our case, Vcc is the operating voltage of the communication circuit in the 4-Series.

When would you want to use this Vcc? If you have a peripheral device attached like a bar code scanner or remote display that operates on 5 volts dc. Provided the peripheral requires 200 mA or less, it can be powered by the 4-Series scale or terminal, eliminating the need for an additional power supply for the peripheral.

The maximum current allowed is 200 mA per communication port and a system total of 400 mA per 4-Series scale or terminal.

Which type of communication ports have the Vcc available?

- RS232
- RS422
- RS485
- PS2 (Vcc is fixed on the PS2 port, not selectable)

Diagrams.

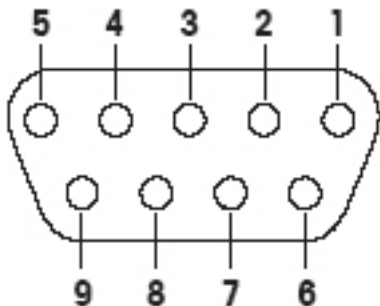

Outside view of RS232 / RS422 / RS485 female connector. Selectable Vcc on pin 9, ground on pin 5.

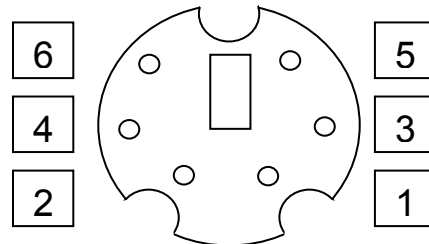

Outside view of PS2 female connector. Vcc fixed on pin 4

- If COM2 has an option installed, other than RS232, the Vcc will always be ON as it is required for the option board.
- COM3, available only with Smart+, does not have Vcc.

Setup of the Vcc power – with Count+ example.
COMMUNI / COM1 / PARAMET / Vcc / ON or OFF

End of demo.

High Resolution: Smart+

With the 4-Series Smart+ we an additional feature of High Resolution (high precision) weighing.

High Resolution: In the high resolution mode the Smart+ displays the weight in higher precision. For a strain gauge scale this is the highest precision possible, for a MonoBloc model the precision is 10 times higher.







There are two basic methods of displaying the High Precision Weight.

- With the “Zoom” view in the “Info” screen.
- In the main display when “HighRes” is selected via softkey.

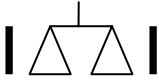
High Resolution weight in the Information screen.







The “Info”, information screen is viewed by touching the “i” key which is the top center key in the right hand keypad.

Main screen of Smart+

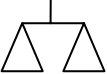
N 0.000 lb T 0.000 lb G 0.000 lb		0.000 lb			
	Smpl 10	Smpl n	APW	Unit	BigDis
					







Touch the “Info” key



Date 04/18/05		0.000 lb			
Time 01 :43 PM					
G 0.000 lb					
	Smpl 10	Smpl n	APW	Unit	BigDis
					

In the “Info” screen (left frame of the display) we have 4 lines available for information. The default “info” is (Line 1) Date, (Line 2) Time, (Line 3) Gross Wt., (Line 4) Accuracy (displayed only in counting mode).

For our demo, let’s change line 3 from Gross to “Zoom” for the High Precision weight.

Date 04/18/05		0.000 lb			
Time 01 :43 PM					
N 0.0000 lb					
	Smpl 10	Smpl n	APW	Unit	BigDis
					

How do I setup “Zoom” in the “Info” screen?

Supervisor Setup:

Application / Info/Help / Line Config. / Info 3 / Edit / Zoom / End / Save / Yes

High Resolution weight in the main display.

In this example we change the softkey 6 assignment from “BigDis” to “HighRes”.

How do I assign “HighRes” to softkey 6?

Supervisor Setup:

Application / Softkeys /Softkey 6 / Edit / High Res / OK / End / Save / Yes

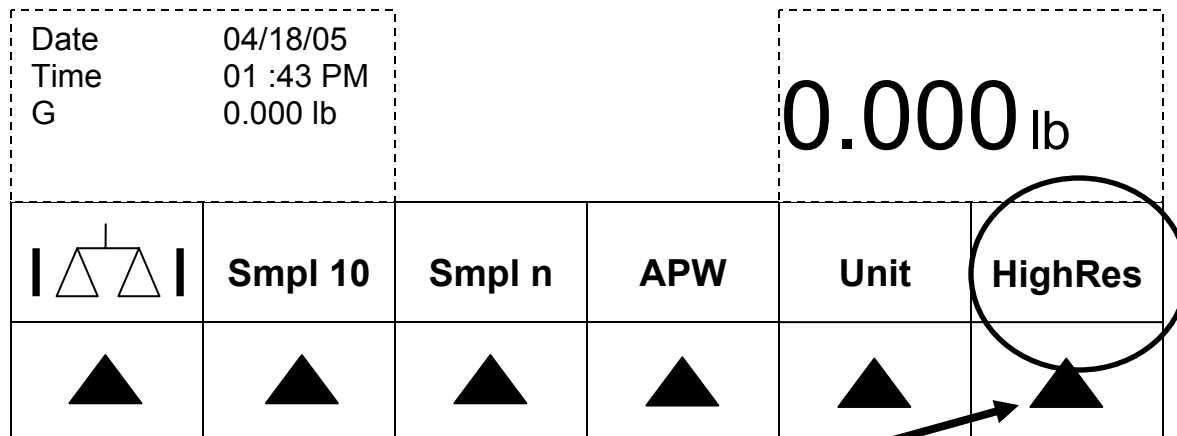

Touch the “HighRes” softkey to switch to High Resolution weight.

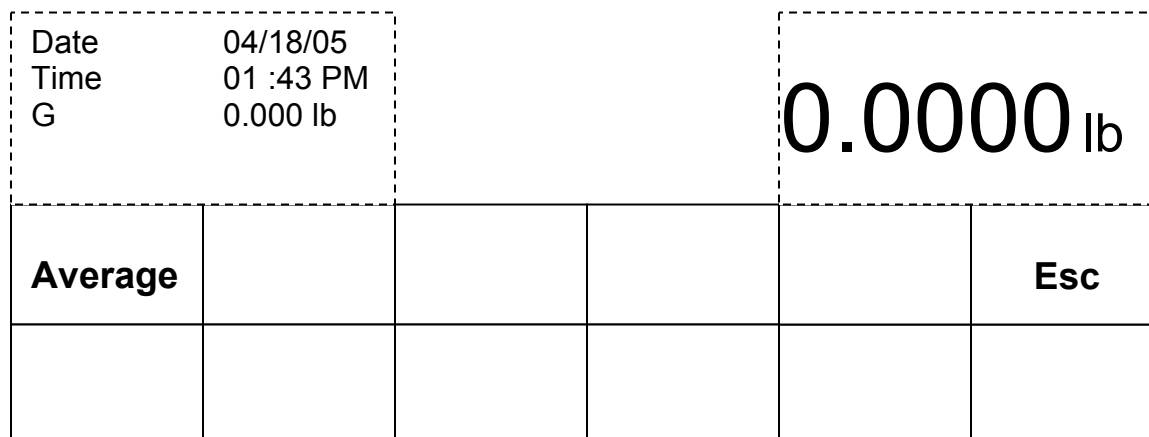

Touch the “Esc” key to return to normal precision weight display.
High Resolution can be used in the Big Display mode too, should you need Big Display of the High Resolution weight.

In this example we used a strain gauge scale with precision of 0.002 lb, in the High Resolution mode the precision was 0.0001 lb. Be aware that in the High Resolution mode the scale will be much more sensitive to the environment and may not be usable for normal operations. The High Precision mode must be used in a very stable environment.

The “Average” softkey illustrated above is explained in a different demo.

End of Demo.

Averaging / Dynamic Weighing: Basic, Count, Count+, Smart+

The dynamic weighing function determines the average weight of a moving sample. The feature is useful for weighing live animals and other samples that cannot be kept stable. Two demos are provided: one for the Basic / Count / Count+ and another for Smart+.

Basic / Count / Count+

Dynamic weighing in these models is an application selection under Supervisor access setup. If selected the scale is used exclusively for dynamic weighing / counting, counting not available with the “Basic” model. For static weighing (normal weighing) the dynamic weighing application must be set to “off”.

To use the dynamic weighing feature, it must first be enabled in the menu. Enter the setup menu and navigate to Application/Dynamic. The feature may be set: Off; Auto Start; or Manual Start. For this demo, we will use dynamic weighing in auto start mode.

The display gives two visual indications that dynamic weighing is enabled. A mouse icon appears at the lower right of the screen, and an asterisk appears at the far left to indicate that the displayed weight is a calculated value.

Place a load on the scale, the stability ring will show beneath the asterisk if the weight is unstable. After approximately 4 seconds the average weight value is calculated and displayed. The display remains locked until the load is removed from the scale.

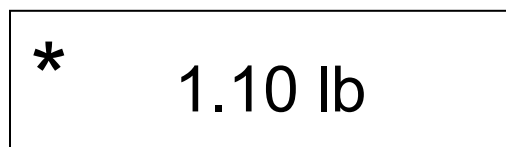
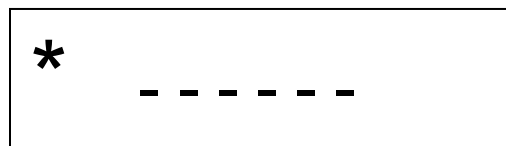
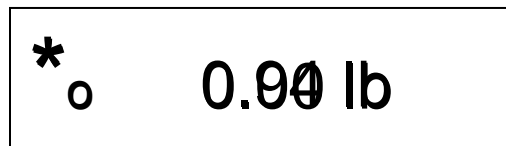

Procedure using auto start with a tare container (auto-clear tare must be set to “no” in setup).

- Place the empty container on the scale.
 - The scale automatically averages the weight.
- Touch the TARE key to tare the empty container.
 - The scale will tare and show 0 net weight.
- Remove the empty container and load the sample inside the container.
- Place the loaded container back onto the scale.
 - The scale automatically averages the net weight.
- For printer applications, touch the print key.

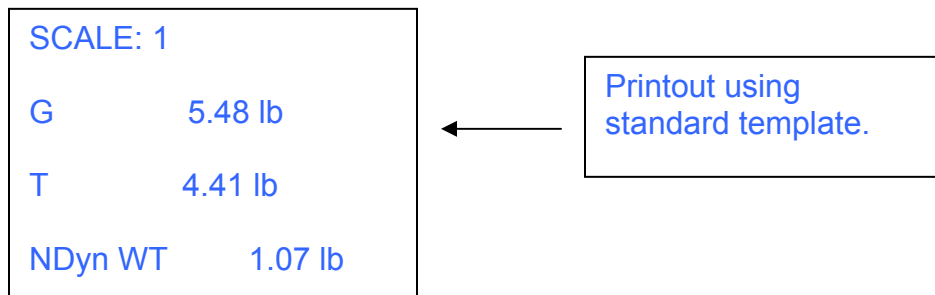

How to setup for Dynamic Weighing with Auto Start?

In Supervisor setup:









Applic / Average / Auto / off key / End – touch print key / Save – touch print key.

Smart+

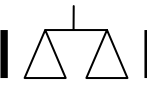







Averaging Weighing: In the Averaging Weighing mode the Smart+ displays the weight averaged over approximately 10 seconds. The Averaging Weighing feature is useful for unstable loads, either weighing or piece counting.

In our demo we will replace the Big Display softkey with the Averaging Weighing Softkey.

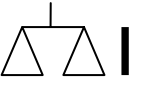
In our demo the Stability detector ring is "on" indicating unstable weight reading.

N	0.486 lb				
T	0.000 lb				
G	0.486 lb				
	Smpl 10	Smpl n	APW	Unit	Average
					

After starting the Averaging process the weight display will switch to dashes and the asterisk illuminates indicating that the display is a converted value (in this case an averaged value).

N	-----				
T	0.000 lb				
G	0.486 lb				
	Smpl 10	Smpl n	APW	Unit	Average
					

After approximately 10 seconds the Averaged value (weight or count) will be displayed.

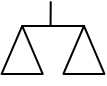
N 0.486 lb T 0.000 lb G 0.486 lb				0.491 lb	
	Smpl 10	Smpl n	APW	Unit	Average
▲	▲	▲	▲	▲	▲

To clear the Averaged value, simply unload the scale and the display will return to normal. The Averaging weighing is constrained to +/- 10% of the applied load, so anytime the weight changes by more than 10% the Averaging function is terminated.

How do I assign “Averaging Weighing” to softkey 6?

Supervisor Setup:

Application / Softkeys / Softkey 6 / Edit / Averageweighing / OK / UP / End / Save – Yes.

End of Demo.

Custom Unit: Smart+

The custom unit is a user configurable unit of measure which is associated with the scale weight or piece count. The custom unit feature can be used as a softkey or recalled from the database.

Demo of custom unit as a softkey:

In this demo we will convert a weight value to a volume, we will convert kilograms to liters, we could just as easily convert from pounds to quarts. In order to use the custom unit we have to know the conversion factor, for our demo we will use whole milk. A typical density for whole milk is 1.03 kg / liter. With this conversion factor we will use the Smart+ to convert weight in grams to liters, where one liter will weigh 1.03 kg.

1.03 kg net = 1 liter







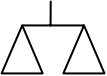

Let's set up a softkey for Custom Unit by changing softkey 6 from Big Display to Custom Unit (CU).

Supervisor Setup:

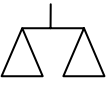





Application / Softkeys / Softkey 6 / Edit / Custom Unit / OK / End / Save / Yes

N 0.000 kg T 0.000 kg G 0.000 kg		0.000 kg			
	Smpl 10	Smpl n	APW	Unit	CU
▲	▲	▲	▲	▲	▲







Now let's setup the custom unit for whole milk.

N 0.000 kg		0.000 kg			
T 0.000 kg					
G 0.000 kg					
	Smpl 10	Smpl n	APW	Unit	CU
					

Touch the CU key
The Custom Unit screen will open.

N 0.000 kg		1			
T 0.000 kg					
G 0.000 kg					
Factor = 1					
SetUnit	Factor	Format	Recall	Save	ESC
					

Set the Unit to Liter
Touch the "SetUnit" key, and key in the unit name of "Liter". Use the right hand keypad to key numbers, lower case and upper case characters. Close with OK key.

					ABC
Unit = Liter					
	Erase	<	>	OK	Cancel
					

At the top right corner of the display is the text “ABC”, this indicates that the keypad is set for Upper Case characters. By touching the “Shift” key, which is the arrow key at the top left position of the keypad, you can rotate the character function from upper case, **ABC**, lower case, **abc**, and numeric, **123**.

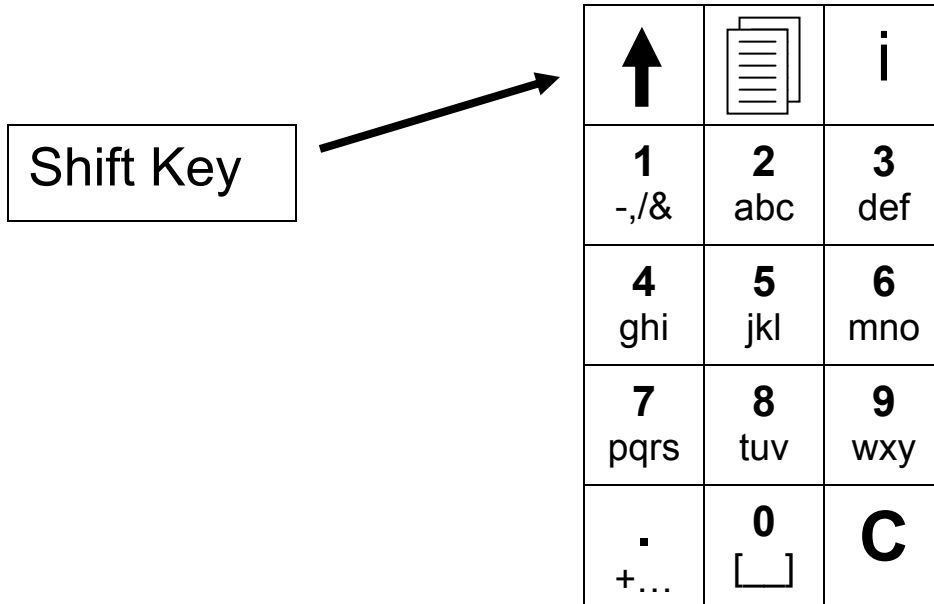

Touch the “Factor” key.

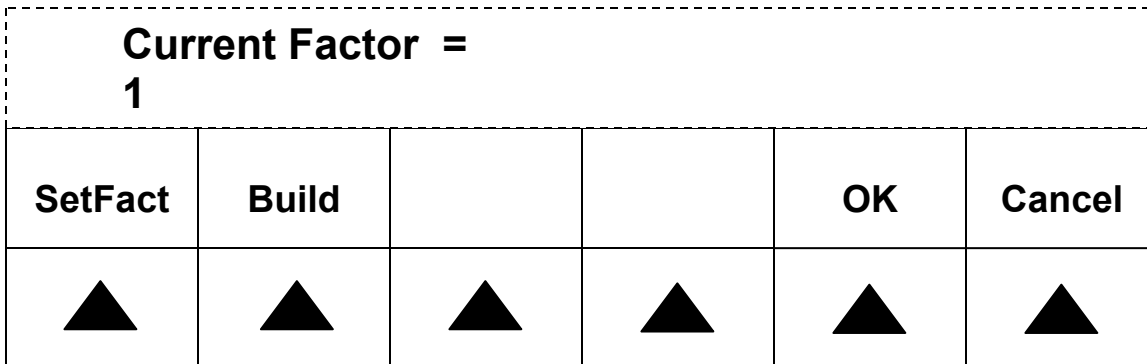

Touch the “SetFact” key, and key in the factor required for our conversion, to convert from weight to custom units.

1.03 Kg = 1 Liter, therefore
1 kg = 0.970874 liters.

Factor: 1 kg = 0.970874 Liters					
	Erase	<	>	OK	Cancel
▲	▲	▲	▲	▲	▲

Close with the "OK" key. The current value is now displayed.

Current Factor = 0.970874					
SetFact	Build			OK	Cancel
▲	▲	▲	▲	▲	▲

Close with the "OK" key.

N 0.000 kg T 0.000 kg G 0.000 kg Factor = 0.980874			0		
SetUnit	Factor	Format	Recall	Save	ESC
▲	▲	▲	▲	▲	▲

Touch the "Format" key to set the precision of the custom unit.

Format = 1					
1	0.1	0.01	0.001	OK	Cancel
▲	▲	▲	▲	▲	▲

For demo touch the “0.01” key to set our precision at 0.01 liters. Close with the “OK” key. The display now shows the weight value in our custom unit of liters.

N 0.000 kg T 0.000 kg G 0.000 kg Factor = 0.970874			0.00 Liter		
SetUnit	Factor	Format	Recall	Save	ESC
▲	▲	▲	▲	▲	▲

If we want to save this custom unit for future recall, we can do so.

New					
▲			Delete	Save	Cancel
▲	▲	▲	▲	▲	▲

Touch the “Save” key

Factorname =					
	Erase	<	>	OK	Cancel
▲	▲	▲	▲	▲	▲

Key in the factor name, "Whole Milk", using the right hand key pad, then touch the "OK" key.

Now the custom unit is saved. To recall the customer unit, touch the "Recall" key.

N 0.000 kg T 0.000 kg G 0.000 kg Factor = 0.970874			0.00 Liter		
SetUnit	Factor	Format	Recall	Save	ESC
▲	▲	▲	▲	▲	▲

Use the Up / Down arrows to high the desired custom unit, then touch the "Recall" key, the scale will display the weight in the custom unit.

1% Milk 2% Milk Whole Milk					
▲	▼			Recall	Cancel
▲	▲	▲	▲	▲	▲

Keep in mind with this demo, that you will have to tare the weight of an empty container in order to get the net volume of liters.

Here are three methods of taring the empty container weight, in weight units, not custom units.

- Place an empty container on the scale, then touch the “Tare” key. Then remove the empty container.
- Setup a PreTare softykey in setup. Then touch the “PT” key and then key in a known tare weight value.
- Use a short entry mode for known tare, example: 0.04 kg. Key in 0.04 then touch the “Tare” key. Use a leading zero for tare weights less than one (1).

After the tare is completed, load the scale with filled container to measure the net weight in custom units.

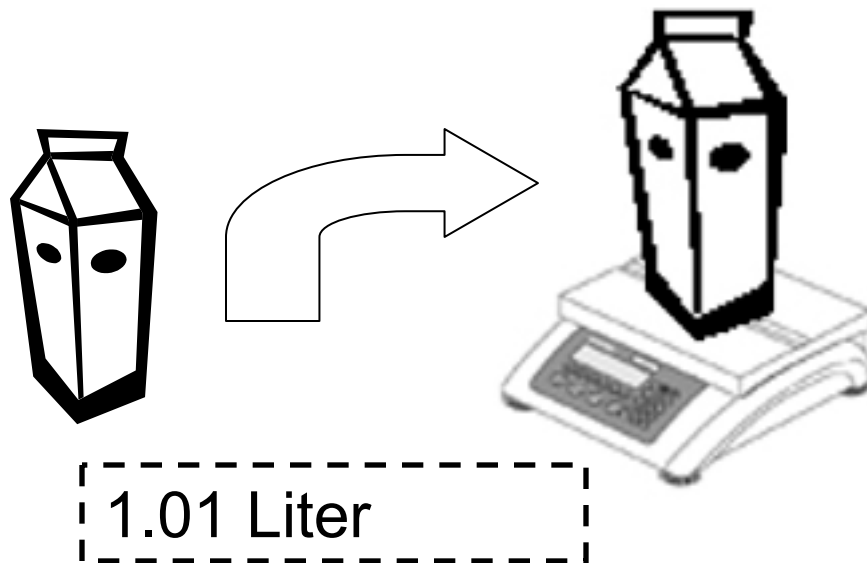

End of demo.

USB installation: Basic, Count, Count+, Smart+

In this demo we will install the USB option into a 4-Series Basic (BBA422). The mechanical installation of the USB option kit (22013144) in the 4-Series Basic is covered in separate option kit instructions (22013618). The installation is straight forward and requires a Torx T20 screw driver. The installation sequence of the mechanical parts is:

- Remove the electrical power from the 4-Series scale.
- Remove the bottom cover.
- Remove the connection plate on the rear of the 4-Series.
- Disconnect the RS232 ribbon cable from the 4-Series main board and remove the RS-232 connector from the connector plate.
- Install the new ribbon cable to USB option board.
- Install the USB option board onto the connection plate.
- Connect the ribbon to the 4-Series main board.
- Install bottom cover.
- Restore the electrical power to the 4-Series scale.

Connector Plate Diagram before:



Connector Plate Diagram after:



The USB port is Com 2 and the RS232 port is COM 1. We still have an RS232 port because the USB option board has both a USB and RS232 connection.

SOP (Set Option)

After the mechanical installation the option must be enabled inside the 4-Series scale. We do this with a PC connected to the RS232 port. Connect an RS232 modem cable (straight through pin to pin, at least pins 2,3,5) between the PC and COM 1 of the 4 Series. The four series has a female 9 pin and most PC have a male 9 pin RS232 connector.

Run a terminal emulation program like “HyperTerminal”, and establish communications between the 4-Series scale and the PC. We will use SICS commands to enable the USB option. (Operation of Hyper Terminal is not covered in this demo). The SICS commands will operate if the 4-Series port mode is DIALOG or PRINT. Default settings for PRINT are 2400 baud, 7 data bits, even parity. Default settings for DIALOG are 9600 baud, 8 data bits, no parity. To set the port settings in the 4-Series Basic to DIALOG:

Setup

Communication / COM 1 / Mode / Dialog / Parameters / Baud / 9600 / Parity / 8 none / H Shake / XonXoff / at this point short cut to exit by touching On/Off key, at the “End” prompt touch the Enter key, at the “Save” prompt touch the Enter key.

Using the Hyper Terminal program, send the command SI (capitol SI terminated with CR (carriage return) LF (line feed). If your connection is working the 4-Series will respond with the current net weight.

```
SI [PC]
S S 0.007 lb [SCALE]
```

Send the USB inquiry to see current status

```
SOP UO [PC, capitol “O”, not zero]
```

```
SOP A 0 [SCALE. The zero at the end means the USB is disabled, or “locked”]
```

To enable the USB port we send the command SOP UO 1

```
SOP UO 1 [PC]
```

```
SOP A [SCALE response, the “A” means the command was successful]
```

Now we can inquire again to confirm the USB option is enabled.

```
SOP UO [PC]
```

```
SOP A 1 [SCALE, the one at the end means the USB option is enabled].
```

The Option board has a USB-B female connector. The USB option does not come with an interconnecting cable. You can supply your own or use METTLER TOLEDO cable 16630200A. The 16630200A cable is USB-A (4 pin square) to USB-B (4 Pin in line rectangle) and is 6 ft / 1.7 meters long.

Attaching the USB cable between 4-Series Basic and a PC.

Attach the USB interconnecting cable, if this is the first time for 4-Series connection via USB you should get a “found new hardware” message on your PC screen.

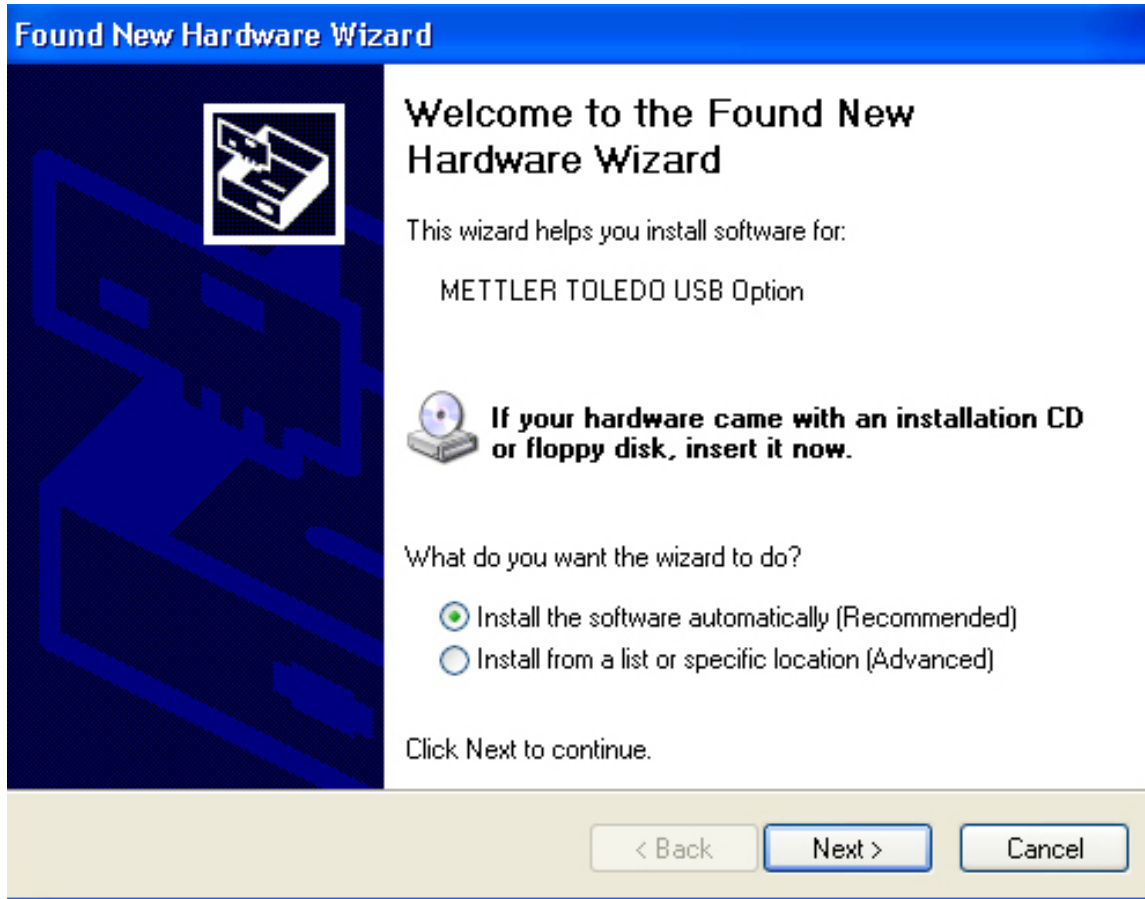

Following the prompts from the PC operating system (Windows XP in this demo), we insert the CD rom which came with the USB option kit (CD number 22010158), select Automatic installation in the windows dialog box and click the “Next” button.

The PC operating system searches for the USB port to identify it.

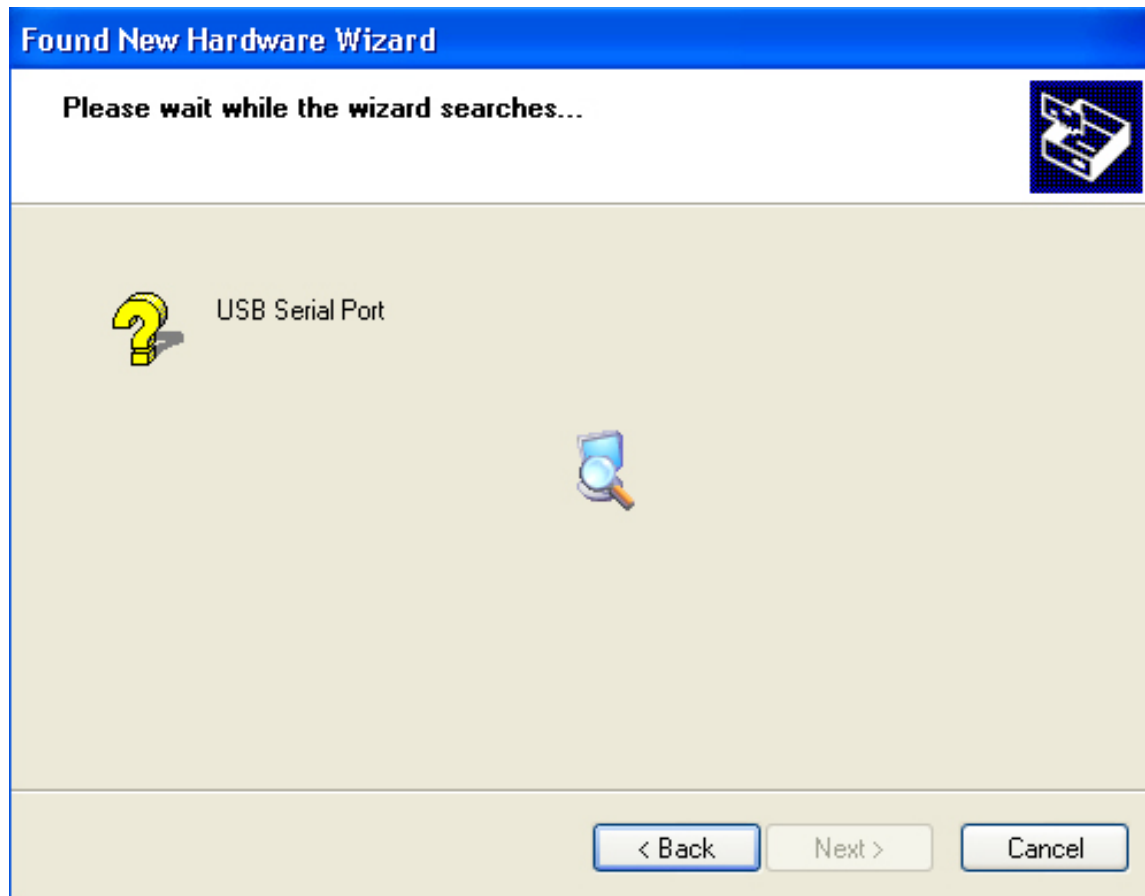

The PC operating systems finds the METTLER TOLEDO USB device and automatically begins the software driver installation.

The PC will automatically find the USB driver and install it on the PC, afterwards we get the installation completed message from the PC.

Found New Hardware Wizard

Please wait while the wizard installs the software...



METTLER TOLEDO USB Option



Setting a system restore point and backing up old files in case your system needs to be restored in the future.

< Back

Next >

Cancel

Found New Hardware Wizard

Please wait while the wizard installs the software...



METTLER TOLEDO Serial Port



ftser2k.sys

To C:\WINDOWS\system32\drivers



< Back

Next >

Cancel

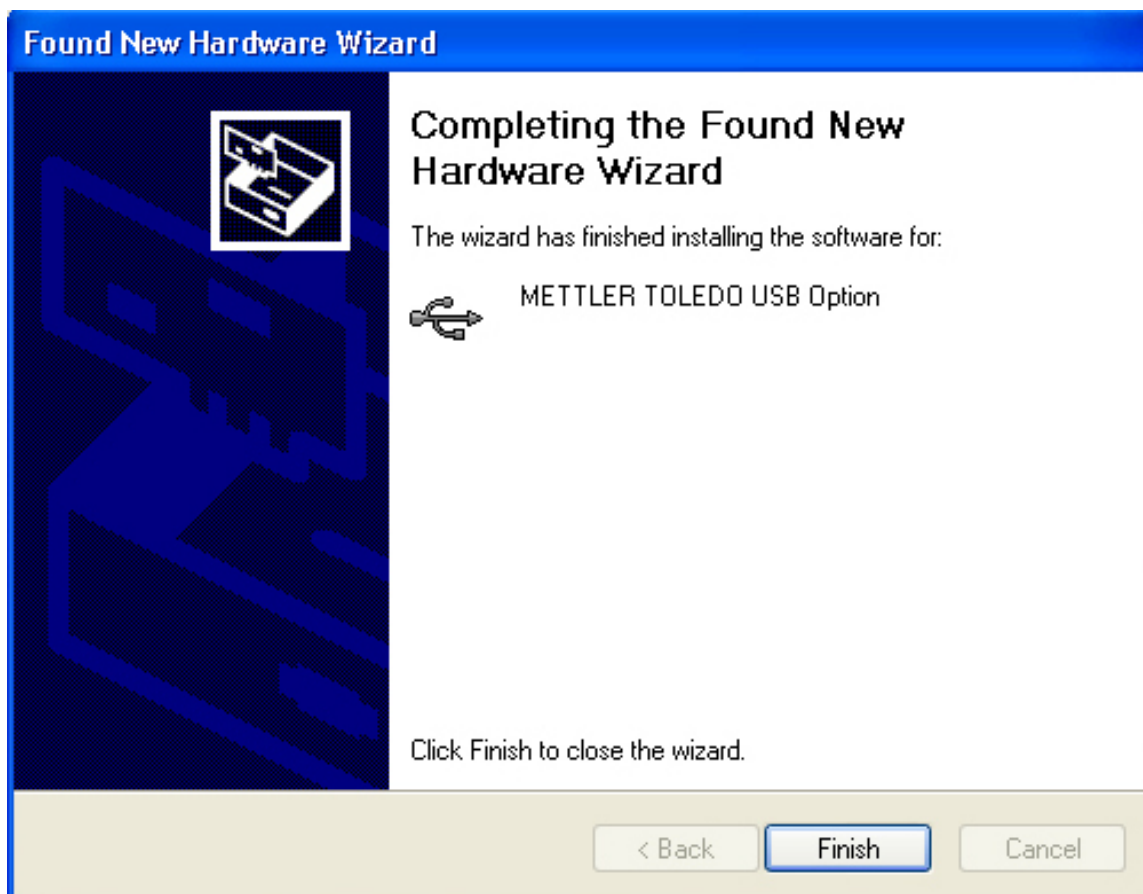

Click the Finish button.

End of demo.

USB Application: Basic, Count, Count+, Smart+

The 4-Series USB port is a USB slave intended for connection to a PC. It is not intended to connect to printers, scanners, etc. because the port is Slave, not Master.

In this demo we will connect a 4-Series Basic (BBA422) to a PC over USB and communicate bi-directional in dialog mode.

Setup the PC application.

We will demonstrate the application Hyper Terminal.

We determine the USB port assignment in our PC, here we use Windows XP.

Open Control Panel on the PC.

Click on “System”



On the System Properties tab, click “Device Manager”

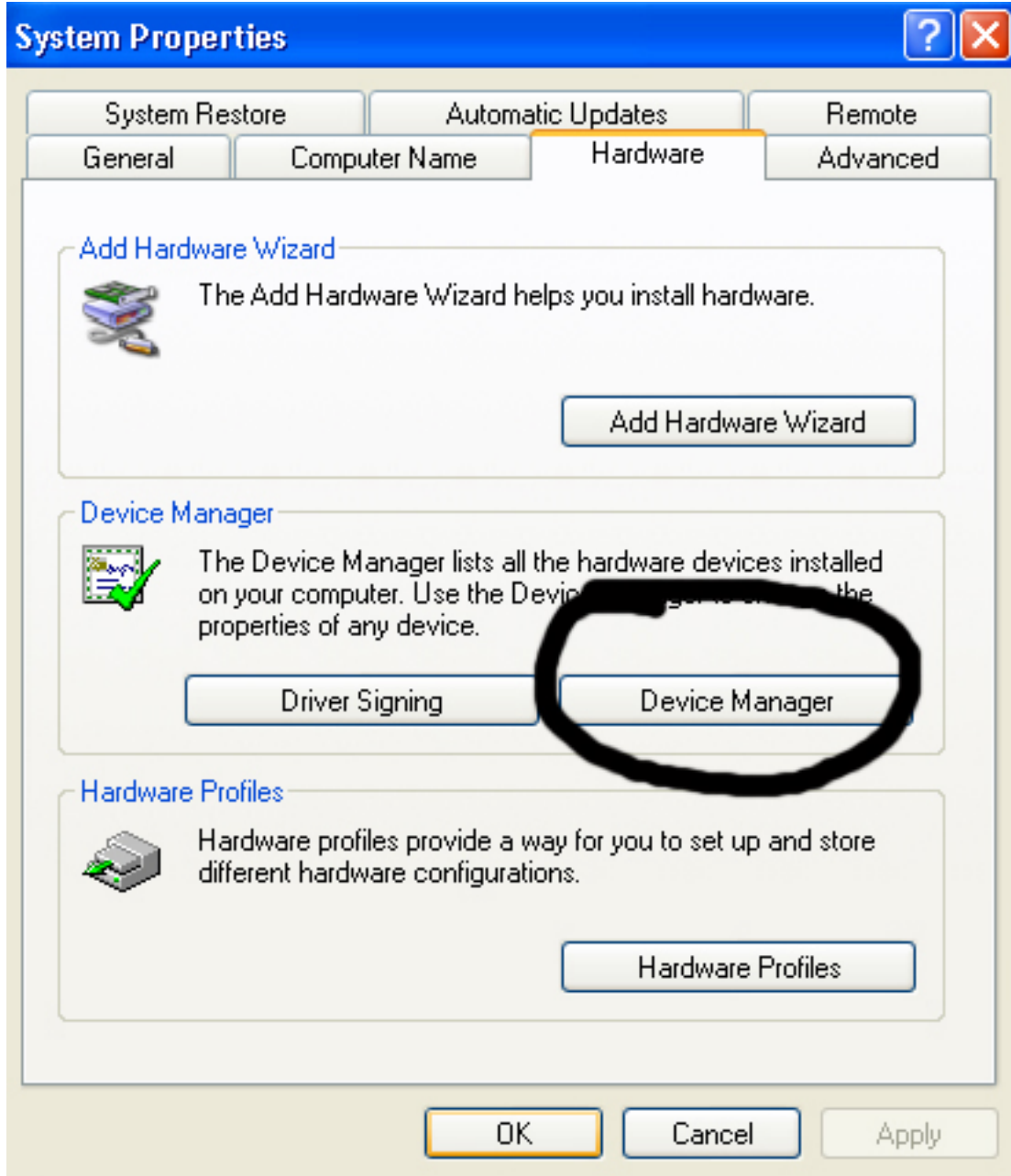

On the Device Manager screen open “Ports (Com & LPT)” to find where the USB port is configured (from the USB installation).

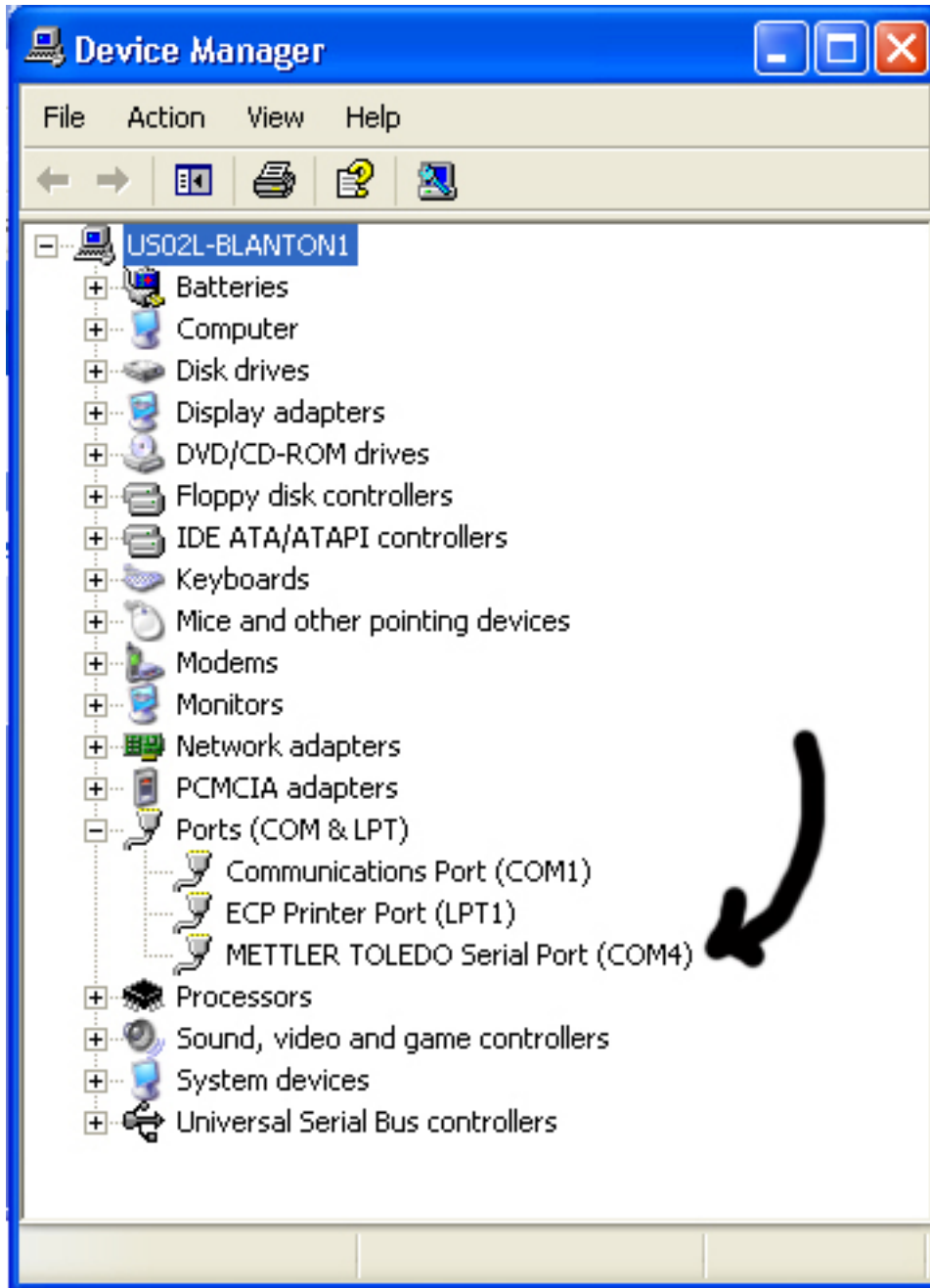

Here we find the USB (METTLER TOLEDO Serial Port) configured on COM 4 of our PC. With this information we can close all control panel windows and proceed with the Hyper Terminal application demo.

This demo is not on how to use Hyper Terminal program and a familiarity of it is assumed.

On the Hyper Term Properties Tab, select Connect to Com 4

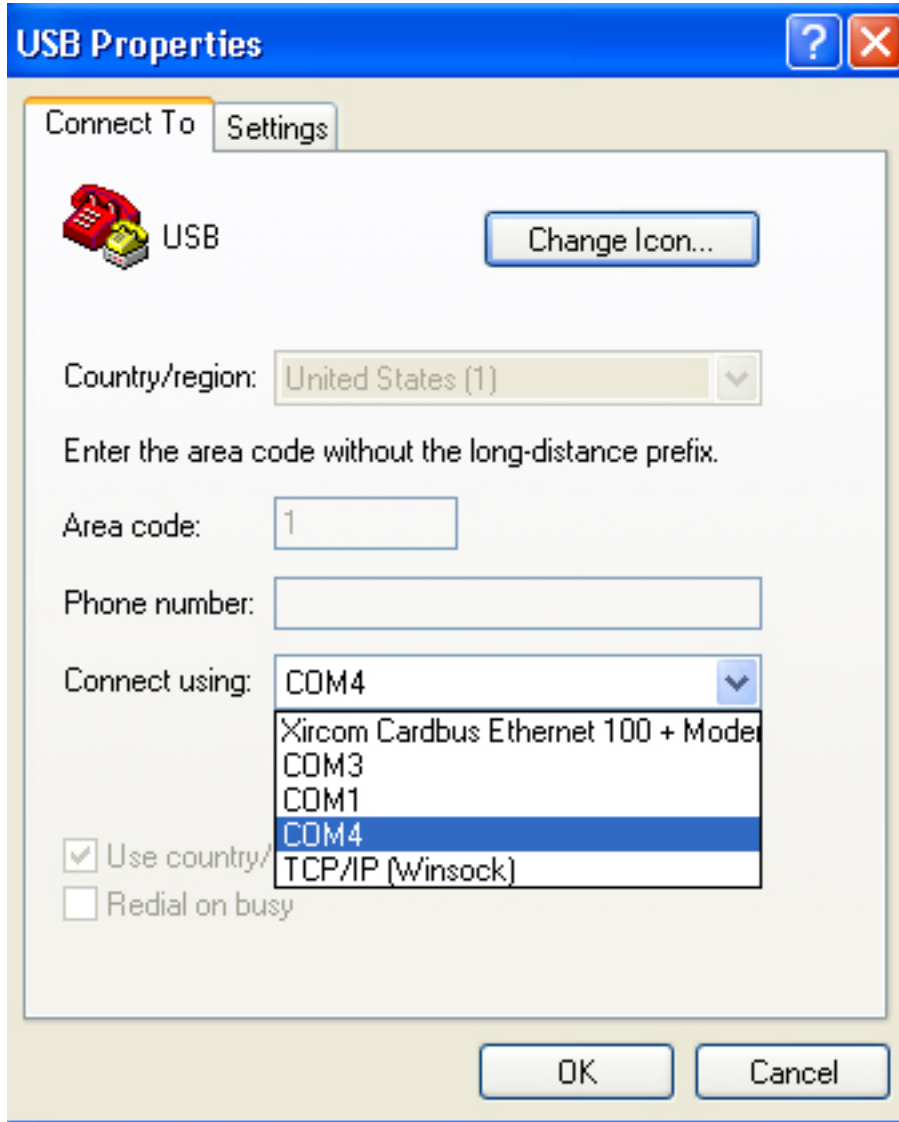

On the Hyper Terminal “Connect To” tab, click the Configure button and set parameters to 9600 Baud, 8 data bits, no parity.

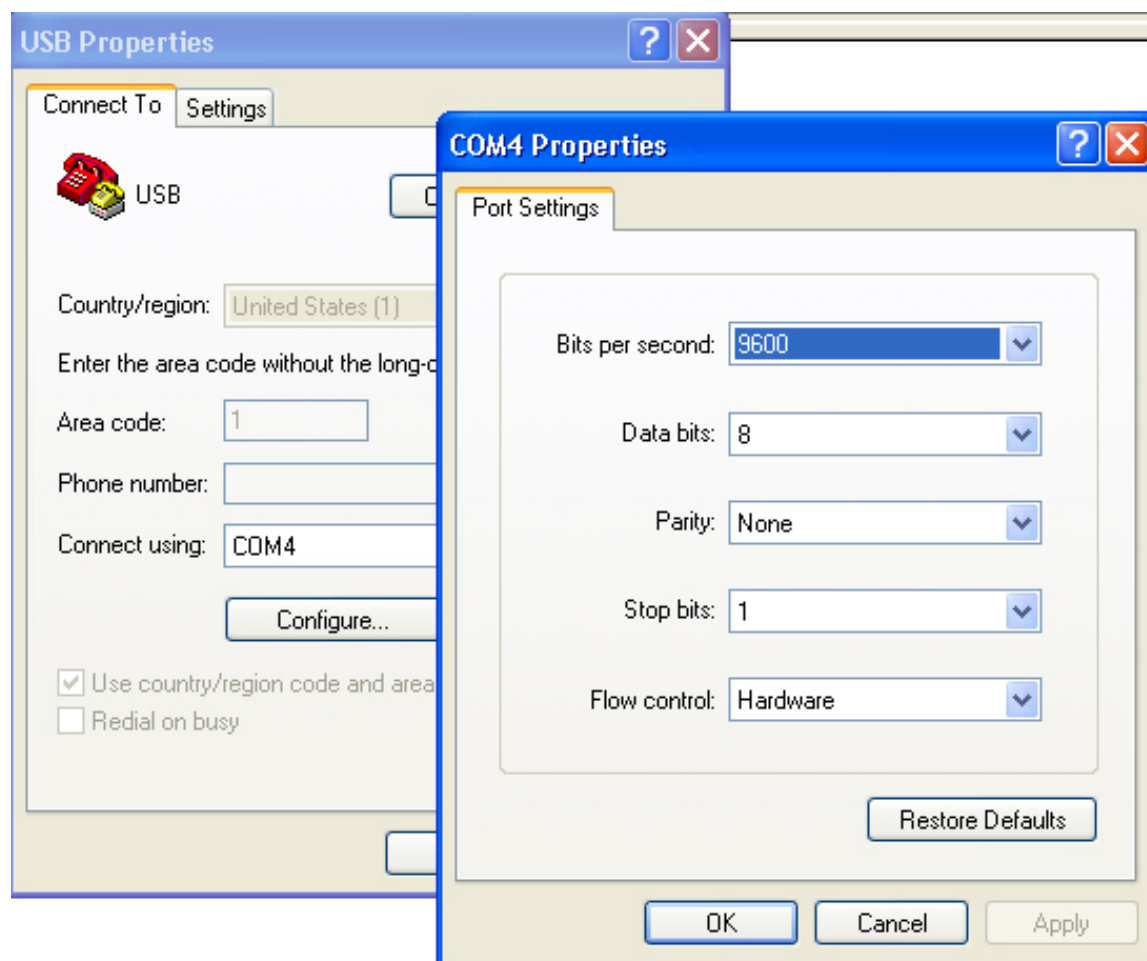

Switch to the “Settings” tab and click the “ASCII Setup” button.

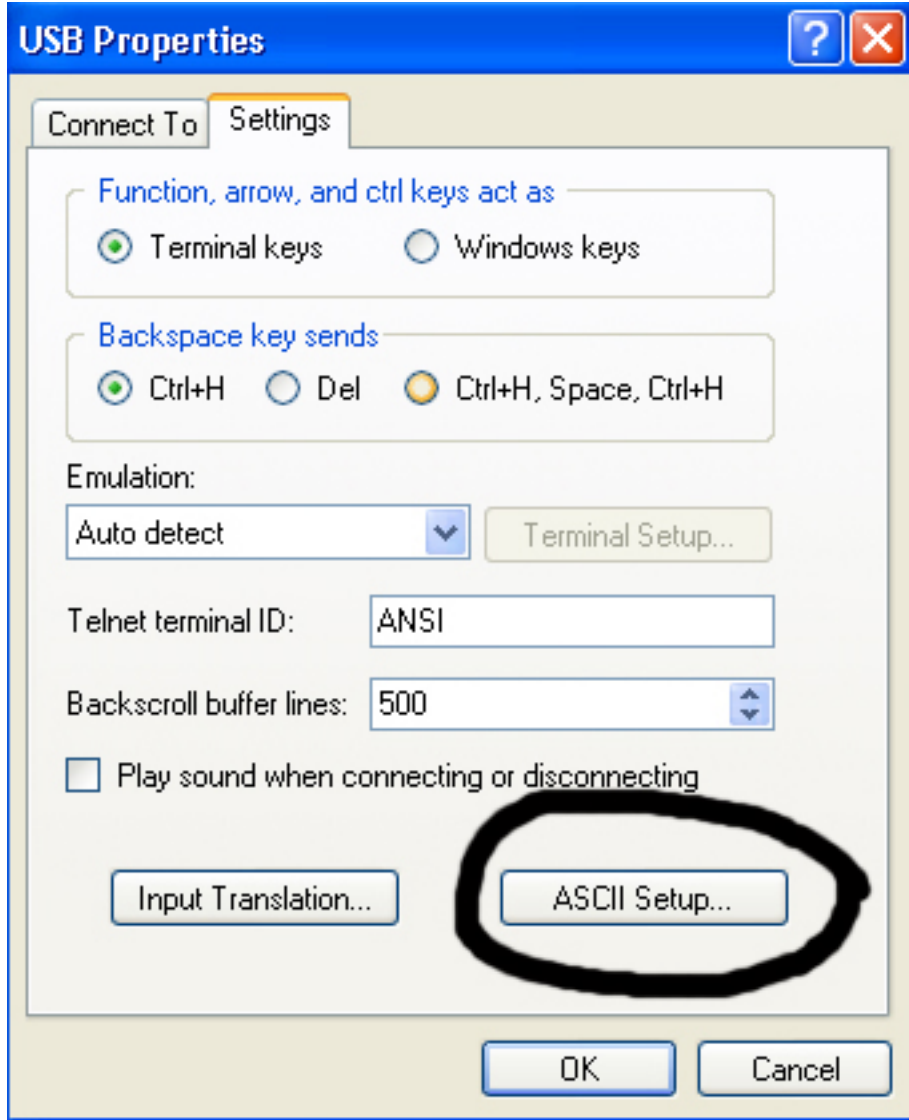

On the ASCII Setup page check mark the “Send line ends with line feeds”. This is required for bidirectional communication with 4-Series.

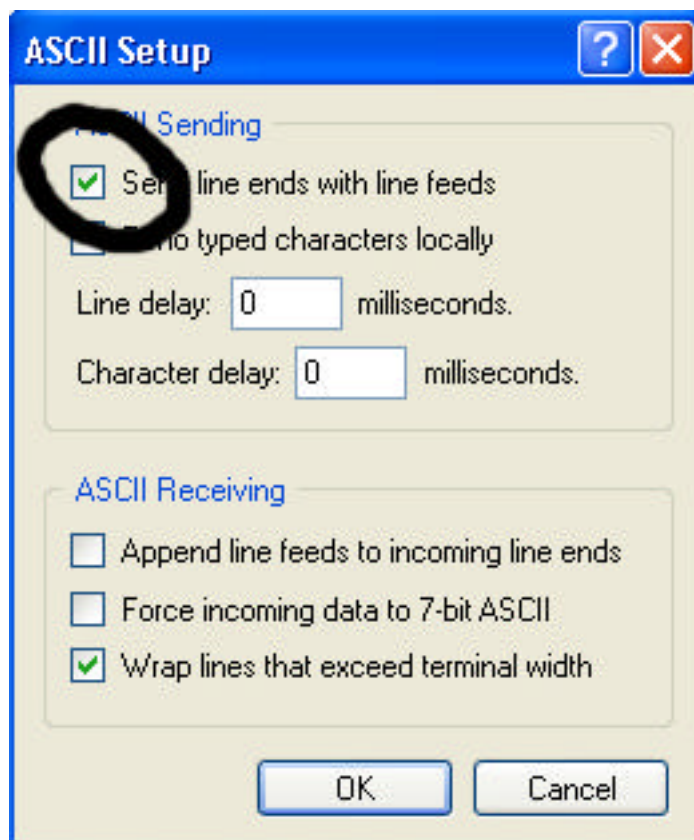

4 Series Scale Setup

In the setup of the 4-Series we will set COM 2 (because this is the USB port) to dialog mode and set the communication parameters.

Go into setup.

- Hold down the PRINT key until “CODE” is displayed
- Key in the Supervisor Password, then PRINT key.
- The top level menu will show SCALE, rotate through the menu with the “no” key, TARE until COMMUNICATIONS (CONNUNI) is displayed.
- Touch the “yes” key, PRINT, to enter the communications menu.
- COM 1 (CON I) is displayed. Rotate to COM 2 with the TARE key.
- Touch the “yes” key, PRINT, to enter the COM 2 menu.
- The mode (NOdE) prompt is displayed, touch the “yes” key, PRINT, to enter the mode menu.
- Rotate through the mode menu with the “no”, TARE key until dialog is displayed (DIALOG), touch the “yes” key, PRINT to select dialog.

- The menu now advances to parameters (PARANet). Touch the “yes” key PRINT.
- Set baud to 9600
- Set parity (Parity) to 8 none (8 nonE)
- Set handshake (HSHAKE) to NO or XONXOFF.
- Touch the ON/OFF key to short cut setup and exit.
- At the End and SAVE prompts touch the “yes” key, PRINT.

Run the demo using Hyper Terminal

Click the “Call” icon to start the session.

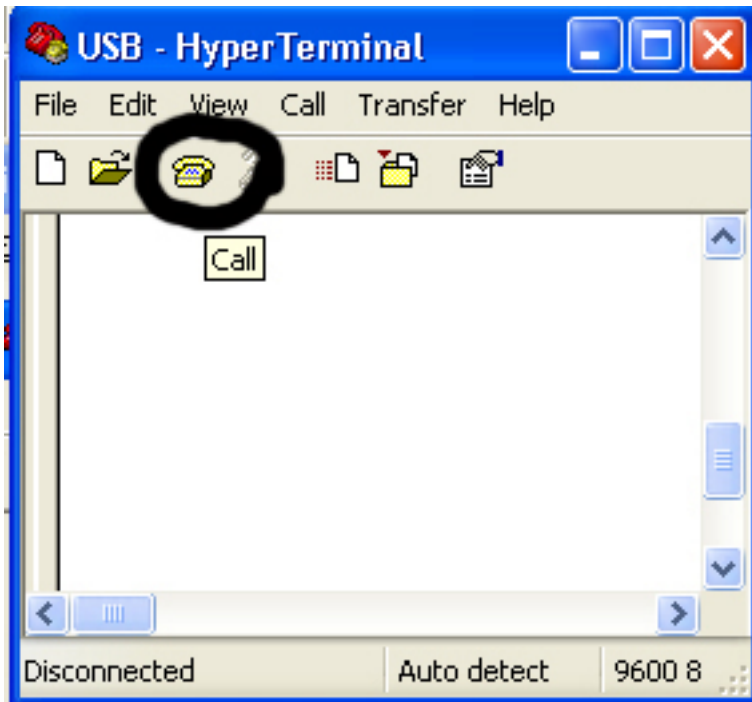

Now we can demonstrate communications by sending SICS commands and receiving the response from the 4-Series scale in the Hyper Terminal screen. Here are some sample SICS commands with the scale responses captured on the Hyper Terminal screen.

SI [Send weight immediate]
I4 [Serial Number]
I2 [Scale model and capacity]

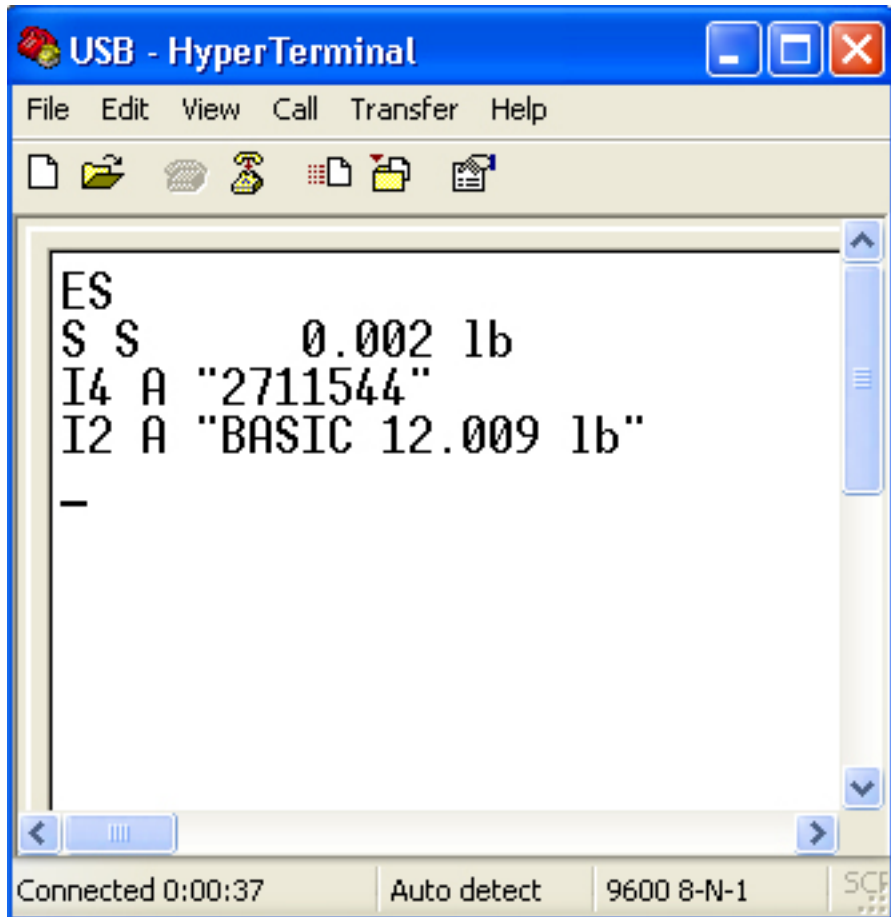

End of demo.

Checkweighing / Filling with PC interface: Smart+

With the 4-Series Smart+ we have the features of +/- Checkweighing and Filling. The target quantities for theses values can be set by:

- Recalling from the database
- Keying in the target directly
- Sending the target values from a PC

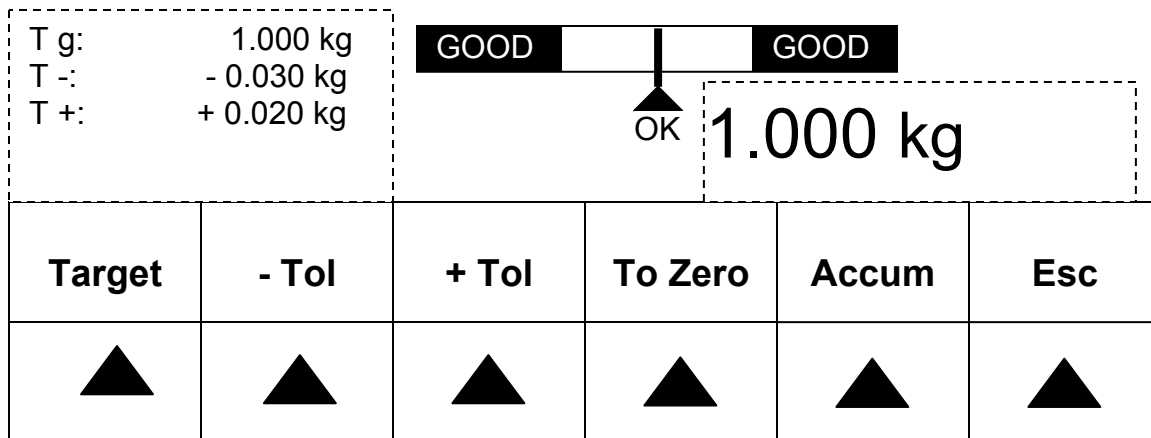

In this demo we show how to send targets with tolerances via a PC over a com port, the COM Port can be RS232, USB or Ethernet.

The serial port and PC communication parameters must match, standard dialog port communication in Smart+ is 9600 baud, 8 data bits, no parity, 2 stop bits.

PM_1000_g_30_g_20_g

(Where PM is the Checkweighing command, 1000 is the target weight, 0.030 is the Tolerance + and 0.020 is the Tolerance -. The unit of measure, in this sample g, must be sent. The underscore character represents a space character in the data string, do not send the underscore character).

The unit of measure can be transmitted in grams (g), kilograms (kg), pounds (lb) or ounces (oz), but not in %. The values used in the Smart+ are the currently selected display unit. For example if the scale is used in pounds and the target values are transmitted in grams, the display will be in pounds (converted from grams).

Smart+ setup

- Communication parameters must match PC. Standard settings:
 - **Setup:** Communication / COM 1 / Mode / Edit / Dialog / Parameters / Baud / 9600 / Parity / 8-none / End / Save – Yes.
- Softkey setup. With the PM command we can write targets for +/- Checkweighing, Filling or both simultaneously.
 - If no softkey is configured the Smart+ will default to +/- Checkweighing and automatically start after receipt of the PM command.
 - If the +/- Checkweighing softkey is configured the Smart+ will default to +/- Checkweighing and automatically start after receipt of the PM command.
 - If the Filling softkey is configured the Smart+ will default to Filling and automatically start after receipt of the PM command.
 - If both the +/- Checkweighing and Filling softkeys are configured the Smart+ will default to +/- Checkweighing and automatically start after receipt of the PM command. By touching the Filling or +/- Checkweighing softkeys you can switch between the applications.
 - **Setup:** Application / Softkey Config / Softkey 7 (or what you want) / Edit / Checkweighing (or Filling) / End / Save -Yes.

Note: This feature is fully implemented in 4-Series Smart+, in Viper Smart Count the target values may be entered but automatic switching to Checkweighing / Filling is not implemented, you must be in the Checkweighing / Filling mode prior to PC data transmission of target.

End of demo.

Restart: Basic, Count, Count+, Smart+

In this demo we use 4-Series BASIC

The “Restart” feature of the 4-Series scales is for tracking the zero and tare values in the case of a power outage. When would you want this feature? An important time to use this feature is when dispensing materials into a container. Another important time is when the container gross weight is greater than the scale power up zero range, this is particularly an issue if the scale is inside a machine or very large and can't be moved without great inconvenience. If you lose electrical power the zero and tare values are cleared, and reset at power up.

Example A: The operator uses a container and manually adds material to the container.

- Operator zeros the scale with the zero key, the scale shows zero.
- Operator loads the empty container on the scale.
- Operator touches the tare key, the scale shows 0.0000 kg net.
- Operator dispenses material into the container
- The scale loses power before the material dispense is completed.

At this point the operator has two options, he can leave the container on the scale or remove the container from the scale.

- If he leaves the container on the scale, the scale will do one of two things.
 - Power up capture zero – and show zero weight gross, in which case the operator does not know how much material is in the container.



A rectangular box representing a scale display. Inside the box, the text "0.0000 kg" is centered. The "0" is significantly larger than the other digits.

- Power up outside the zero capture range and not show a weight at all, in which case the operator must remove the container to zero the scale.

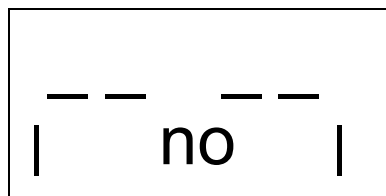

A rectangular box representing a scale display. Inside the box, there are four horizontal dashes arranged in two pairs, with the word "no" centered between them. Vertical bars are on the left and right sides of the dashes.

- After loading the container back on the scale he still does not know the net weight of the material.

2.7680 kg

- Either way, we do not know the **net** weight of the material

This is where the RESTART feature is useful.

Here is how our scenario works if we had RESTART turned on.

- Operator zeros the scale with the zero key, the scale shows zero.
- Operator loads the empty container on the scale.
- Operator touches the tare key, the scale shows 0.0000 kg net.
- Operator dispenses material into the container.
- The scale loses power before the material dispense is completed.
- The power is restored.
- The scale display shows the net weight value, for example 1.6450 kg

NET
1.6450 kg

- Operator resumes the dispensing

The restart feature is also useful for operations where the weighing is conducted over a long period of time, usually unattended, where material is added or discharged slowly.

Setup for 4-Series Basic

Setup / SCALE / RESTART / ON / End / Save – yes.

End of demo.

Checkweighing / Filling by COUNT: Smart+

In Smart+ we have the features of +/- Checkweighing and Filling. These features can use target values of weight or pieces. In this demo will operate the Smart+ to +/- Checkweigh in pieces mode.

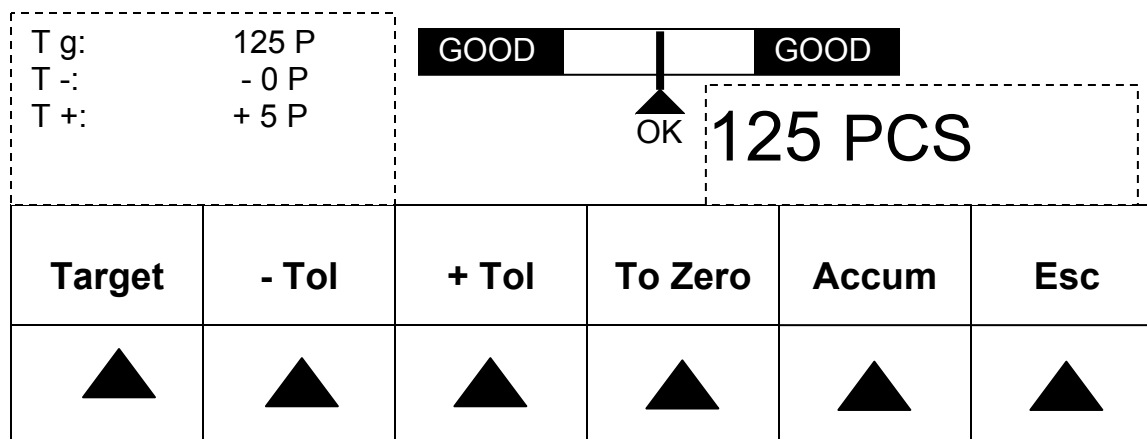





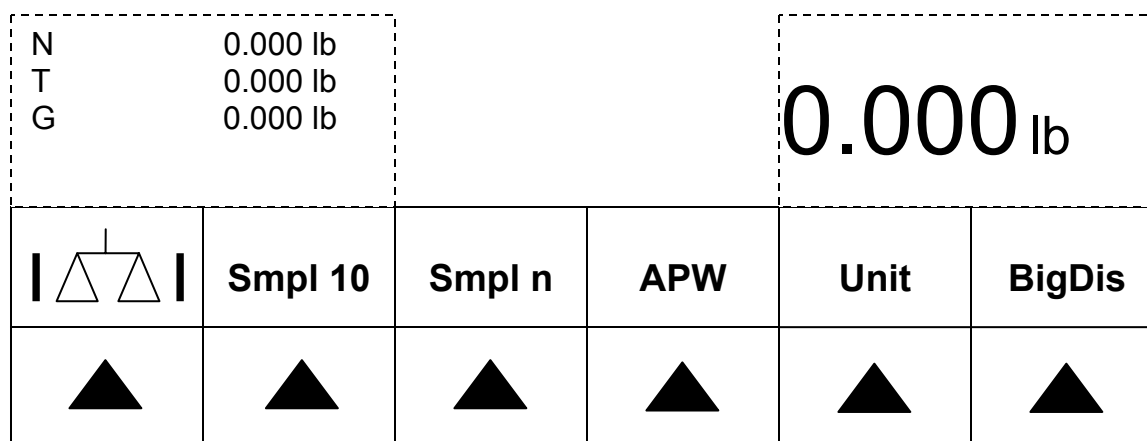

As you can see in diagram above, we can have asymmetrical tolerances, even 0 tolerance. For our demo we use a target of 125 pieces, with zero (0) tolerance for under count and five (5) pieces for over tolerance.

We will set our target from the keyboard, note, that for PIECE COUNT TARGET the Smart+ must have PIECE WIEGHT established.

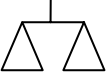
Starting from the default configuration of the Smart+, we will change softkey 6 from Big Display to +/- Checkweighing.









Setup: APPLICATION / Softkey Config / Softkey 6 / Checkweighing / OK / End / Save – Yes.

N 0.000 lb T 0.000 lb G 0.000 lb		0.000 lb			
	Smpl 10	Smpl n	APW	Unit	+ / -
					







The setup is now complete. Now we operate the Smart+ scale.

Establish the average piece weight by either sampling with the Sample 10 key, the Sample n key or by keying in the known average piece weight, APW. We will sample with 10 pieces.

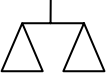
Place 10 pieces on the scale, and touch the Smpl 10 key.







N 0.088 lb T 0.000 lb G 0.088 lb		0.088 lb			
	Smpl 10	Smpl n	APW	Unit	+ / -
					

The scale will establish the average piece weight and switch to piece count mode.







N 0.088 lb		10 PCS			
T 0.000 lb					
APW 0.008831 lb					
	Smpl 10	Smpl n	APW	Unit	+ / -
					

Now we set the target count for +/- Checkweighing.

Touch the "+/-" key, the +/- Checkweighing screen opens.

T g: 0 P		10 PCS			
T -: Invalid					
T +: Invalid					
Target	- Tol	+ Tol	To Zero	Accum	Esc
					

Touch the Target key to open the Target screen, and touch the Edit key.

10 PCS										
					Weigh In	Edit				Cancel
										

Type in Target as
absolute pieces

Target = PCS

	Erase	<	>	OK	Cancel
▲	▲	▲	▲	▲	▲

Using the numeric keypad, key in “125”, then touch the OK key. With the target piece count set, we now set the tolerances.

T g: 125 P						10 PCS
T -: Invalid						
T +: Invalid						
Target	- Tol	+ Tol	To Zero	Accum	Esc	
▲	▲	▲	▲	▲	▲	

We will use relative tolerances, this means the tolerance is based on the target value. Absolute means the tolerance is from zero (0), and % means percentage from target. Touch the “- Tol” key, the set tolerance screen opens, then touch the “Rel” key.

T g: 125 P						10 PCS
T -: Invalid						
T +: Invalid						
Rel	Abs	%			Cancel	
▲	▲	▲	▲	▲	▲	

The set tolerance screen opens, key in the value “0” and touch the “OK” key.

Type in lower tolerance as relative pieces.
T - = PCS

	Erase	<	>	OK	Cancel
	▲	▲	▲	▲	▲

T g: 125 P	T -: - 0 P	T +: Invalid	10 PCS		
Target	- Tol	+ Tol	To Zero	Accum	Esc
▲	▲	▲	▲	▲	▲

Now enter value for + Tolerance, key in the value of 5 pieces.
 With target and both tolerance values set, the +/- deltatracc now displays.

T g: 125 P	T -: - 0 P	T +: + 5 P	 ▲ <T1	10 PCS	
Target	- Tol	+ Tol	To Zero	Accum	Esc
▲	▲	▲	▲	▲	▲

With 125 pieces loaded we are "OK".

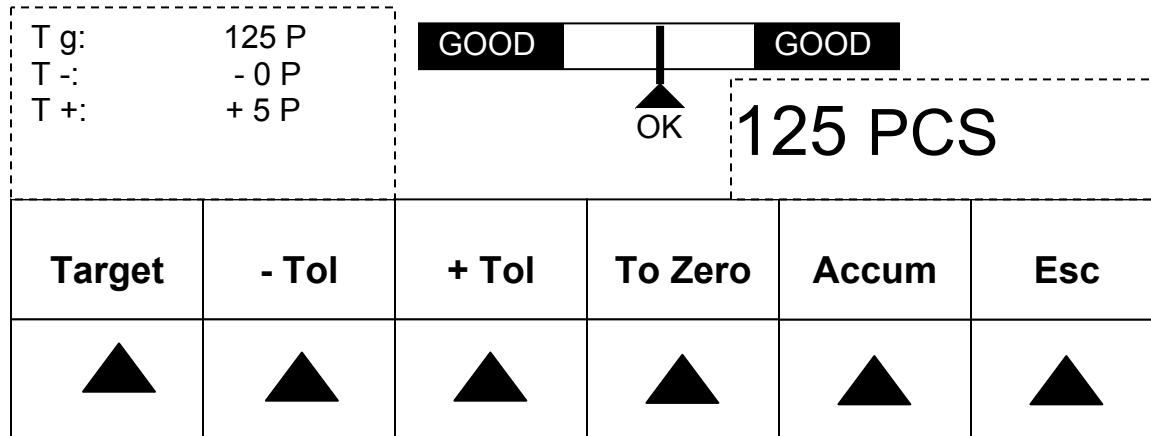

End of Demo.

Checkweighing / Filling by Weight or Count: Count+



The 4-Series provides two Checkweighing features: by Weight and by Count. These features assist the user in measuring to a target weight or a target count within a tolerance range. In this demo we will set up memory locations to accept target values and then set up and recall saved targets.

The Count+ scale has 100 memory locations, which can be designated to store four types of values:

1. Tare values
2. Average piece weights
3. Target weights
4. Target quantities

By default, the 10 memory locations numbered 81 to 90 are reserved for target weights, and the 10 memory locations numbered 91 to 100 are reserved for target quantities or counts.







First, we will demonstrate how to configure the memory partitions.

1. To change the memory assignments, enter the setup menu. Navigate to Application / Memory / Config and press PRINT  to confirm.
2. The display will show three numbers separated by dashes. For factory default settings, the display will show 40-40-10. Use the TARE  key to scroll and view the entire prompt. These numbers represent the current partitioning of the memory. By factory default, the memory is partitioned as follows:

• Tare values	40 locations	1-40
• Average piece weights	40 locations	41-80
• Target weights	10 locations	81-90
• Target quantities	10 locations	91-100
3. To change the partition, enter numbers separated by the “.” key. Note that only three numbers are entered. The scale calculates the fourth range automatically. For example, entering “30.30.20” will change the partitions to the following:

• Tare values	30 locations	1-30
• Average piece weights	30 locations	31-60
• Target weights	20 locations	61-80
• Target quantities	20 locations	81-100
4. Press PRINT  to confirm.

Next we will demonstrate how to save a target weight.

1. To save a target weight, first enter the memory location number where the target weight will be stored. For example, enter “61” and hold down the TARGET  key until the “TARGET” prompt appears.
2. Enter the target weight, for example 4.4 lb. Note that the scale must be operating in units of lb in order to enter a target weight in lb. Press PRINT  to confirm, or press TARE  at any time to abort entering the target weight.
3. The display will now prompt you to enter the + tolerance. We will enter the tolerance value in per cent. Press PRINT  again, enter 5, and press PRINT  to confirm. The upper tolerance is 5% of 4.4 lb, which is 0.22 lb.
4. Enter the lower tolerance. We will enter the tolerance value in the current units. Enter .1 and press PRINT . The lower tolerance is 0.1 lb.
 - a. We could use % tolerance or weight value tolerance, both demonstrated here.
5. The scale is now in checkweighing mode.
6. This is our target value with tolerances:

TARGET	4.40 lb
TOLER. (+)	0.22 lb [value was calculated as 5% of target]
TOLER. (-)	0.10 lb

Saving a target quantity is similar to saving a target weight.

1. Enter the number of a memory location that is designated for target quantity storage. For example, enter 95 and hold the TARGET key until “TARGET” appears on the display.
2. Key in the target quantity, say 20, then touch the print key to confirm.
3. Enter the upper tolerance, for example, 1, then the lower tolerance, for example, 0, as demonstrated for target weights.
4. After the tolerance values have been entered, the scale switches to checkweighing mode.
5. This is our target quantity with tolerances:

TARGET	20 PCS
TOLER. (+)	1 PCS
TOLER. (-)	0 PCS

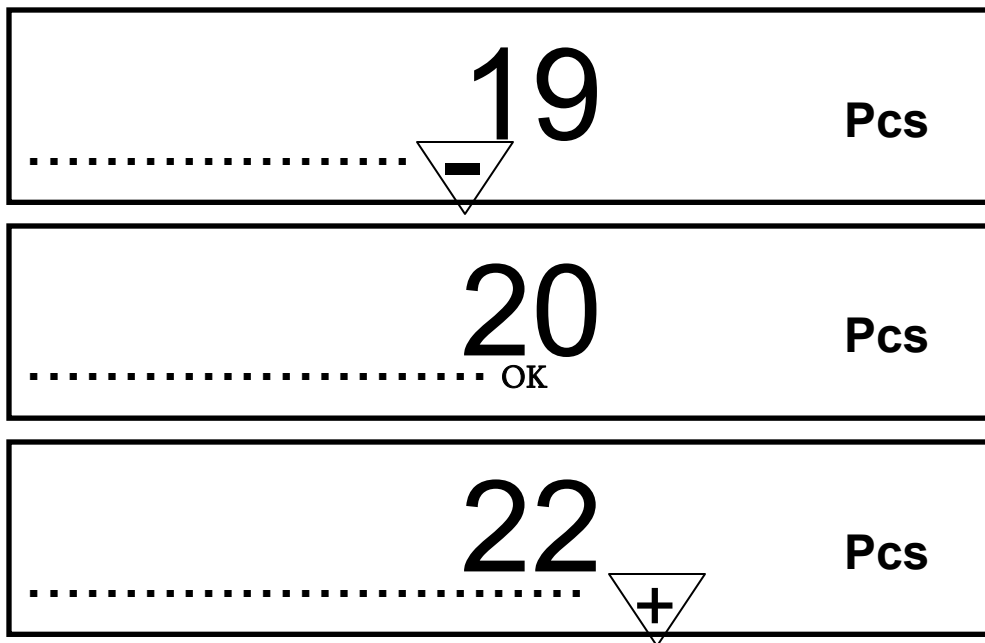



While the scale is in checkweighing mode, a progress bar indicates where the current weight or piece count falls in reference to the target weight or target quantity value.

The scale automatically enters checkweighing mode after a target value is stored. To enter checkweighing mode from normal weighing mode, you can call up a previously saved target.

1. Enter the number of the memory location where the target weight or target count is stored and press TARGET  briefly. For example, enter 61 and press TARGET.
2. The scale displays the saved target weight and the tolerances before it enters checkweighing mode. If no value has been saved in that memory location, the scale displays "--no--" and returns to normal weighing mode.
3. A progress bar informs the user whether the load is above, below, or within the tolerance values. When the load approaches the target value and falls within the tolerances, OK appears above the progress bar. A triangle labeled – or + indicates that the load is below or above tolerances.

A recalled target weight is always displayed in the current units, even if it was stored in different units.

An individual target weight can be cleared from memory. Enter the memory location number and press TARGET  briefly to call up the target weight. Press CLEAR  quickly – within two seconds – and hold the key only briefly. The display will flash "CLEARED" for an instant to confirm that the target weight has been deleted. The scale then returns to normal weighing mode.

End of Demo.

Scale Calibration in Supervisor Access: Basic, Count, Count+, Smart+.

The 4-Series has the feature of user calibration, which allows the user with the Supervisor password to calibrate the scale. This is different from the Technician calibration, which has full access to all scale setup features.

In this demo we will perform an external (external weights are used) calibration on a 4-Series Basic model BBA422-6 PM in Supervisor setup mode.

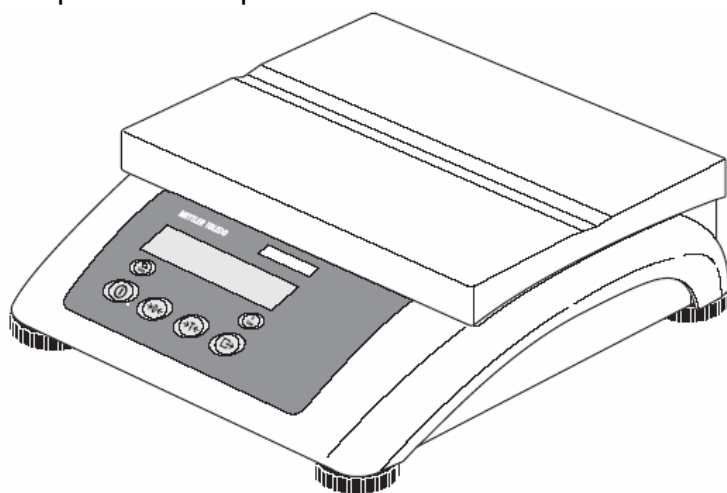

Our demo uses a 6 kg scale setup in the standard configuration of 6 kg capacity and readability of 0.0005 kg. The customer uses metric calibration weights.

- Before calibrating the scale it is good practice to empty scale, make sure the scale is level and that there is no interference from material touching the scale.
- Access the Supervisor mode by pressing and holding the PRINT key until the message “CODE” is displayed, release the PRINT key.
- Key in the Supervisor password, followed by touching the PRINT key.
 - The 4-Series Basic scale is shipped from factory with an empty supervisor password, in which you need press only the PRINT key.
 - If a Supervisor password has been created, use this password.
- The first menu in the Supervisor setup is SCALE, which we want, touch the PRINT key.
- The first menu item under SCALE, is CAL, which we want, touch the PRINT key.

- The scale will flash “ - 0 – “, prompting us to empty the scale, which we already did. The scale will reference the zero reading but will not adjust the calibrated zero value. The scale must be within approximately 5% of the calibrated zero value to proceed, otherwise the scale will continue to flash “ - 0 - “. To cancel the calibration, touch the ON/OFF key.
- The scale display will flash a suggested calibration weight, this will be the largest weight value possible based upon the scale capacity (the scale capacity that was set in Technician mode “Scale Build”). For our demo the suggested weight is 6.000 kg.
 - We can change this weight value by touching the TARE key to scroll through a list of calibration weight values. For our demo the list of values is: 6.000 kg, 5.000 kg, 4.500 kg, 4.000 kg, 3.500 kg, 3.000 kg, 2.500 kg, 2.000 kg, 1.500 kg, 1.200 kg, 1.000 kg, 0.900 kg, 0.800 kg, 0.700 kg, 0.600 kg, 0.500 kg, 0.400 kg, 0.300 kg, 0.200 kg and 0.100 kg. A large selection that should work for the customer.
 - **DO NOT TOUCH THE PRINT KEY** until you have loaded the calibration weights on the scale.
 - Load the correct value of calibration weights on the scale.
 - Touch the PRINT key.
 - The scale calibrates itself and displays “ – donE - “, and advance to the next menu step, “dISPLAy”
 - Touch the ON/OFF key to short cut the setup menu and exit, at the “End” prompt touch the PRINT key, at the “SAVE” prompt touch the PRINT key.
 - Scale is now in normal operating mode.
 - Remove the calibration weights.

Notes: If the customer weights are in a different unit of measure, lb instead of kg, this can be changed in the DISPLAY section of the SCALE menu. The supervisor calibration uses the display unit 1 setting.

End of demo.

Printing Multiple Labels: Smart+

With the 4-Series Smart+ we have the feature of printing multiples of the same label, for when you want two or more identical labels.

This feature is very simple to use and requires no special setup.

TLP2844

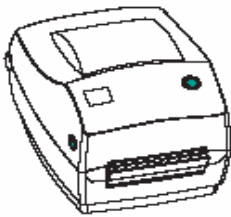

LP2844

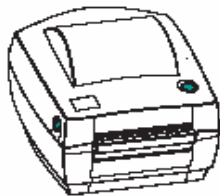

8867

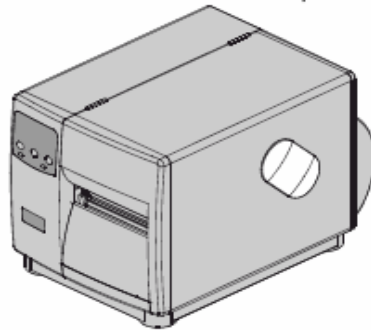

LP2824

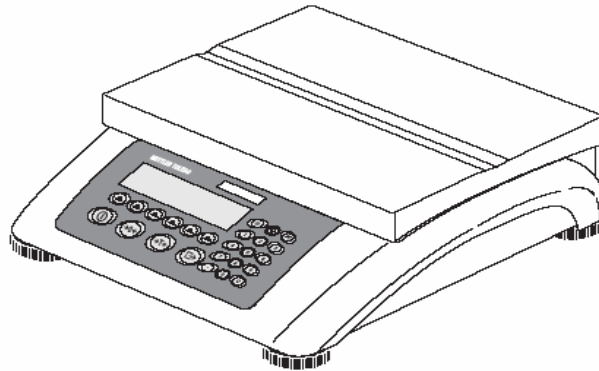

8863

Series 4- Smart+

Smart+ prints multiple labels:

MT 8863

MT 8867

Zebra LP2824

Zebra LP 2844

Zebra TLP 2844

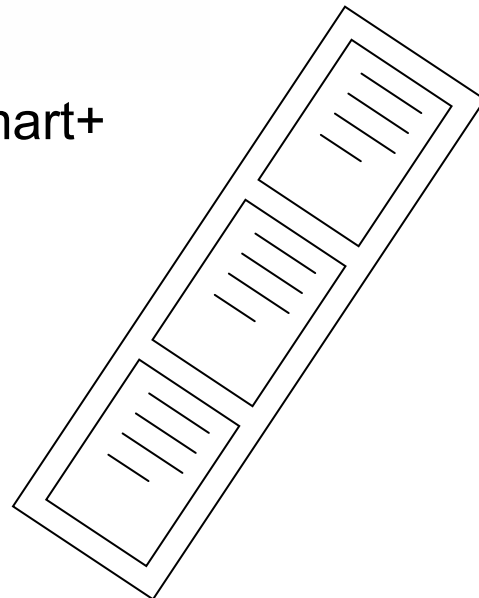

Operation for printing multiple labels.

Use the numeric keypad and key in the number of labels you want, between 1 and 100. Then touch the PRINT key, that's it!

Setup: no setup required for multiple printing.

IMPORTANT Note: The command to print multiple labels is transmitted along with the label data, the Smart+ does not send the label repeatedly. Therefore you must select the appropriate label format in the Smart+, you can not select ASCII printer or any printer other than those listed in this demo. **The multiple label feature will not work in cases where the label template is resident in the printer**, such as the 8863 in "MT" mode, in this case the printer would try to print the multiple label command instead of executing it.

End of demo.

Digital I/O: INPUT: Basic, Count, Count+, Smart+

The digital I/O option port in the 4-Series provides us with 4 optically isolated inputs and 4 optically isolated outputs. All power is supplied externally.

In this demo we will look at connecting a **remote input** to a 4 Series Basic scale.

The Digital I/O option kit for basic / count and count + is part number 22013142. The option installs inside the scale (or terminal) and field connection is via a 9 pin female connector mounted on the connector plate at the rear of the scale.

In a 4-Series Basic scale the option is installed as port 2, port 1 remains as RS232. In the Basic scale we can have one option, so if we choose digital I/O we can not add any further options, such as Ethernet.

The installation of the Digital I/O kit is explained in the installation instructions, 22013616, supplied with the kit. The kit may also be factory installed when ordered together with the scale. See specifications.

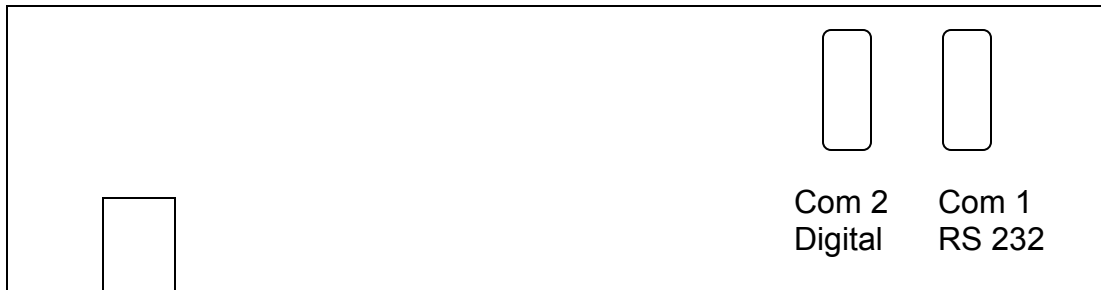

Connector plate on rear of scale / terminal.

How does the input circuit work?

The input circuit is optically isolated from the internal circuitry, which means you must provide an external power source. When we connect the external power sourced to the input circuit an optical coupler is energized, turning on the input signal.

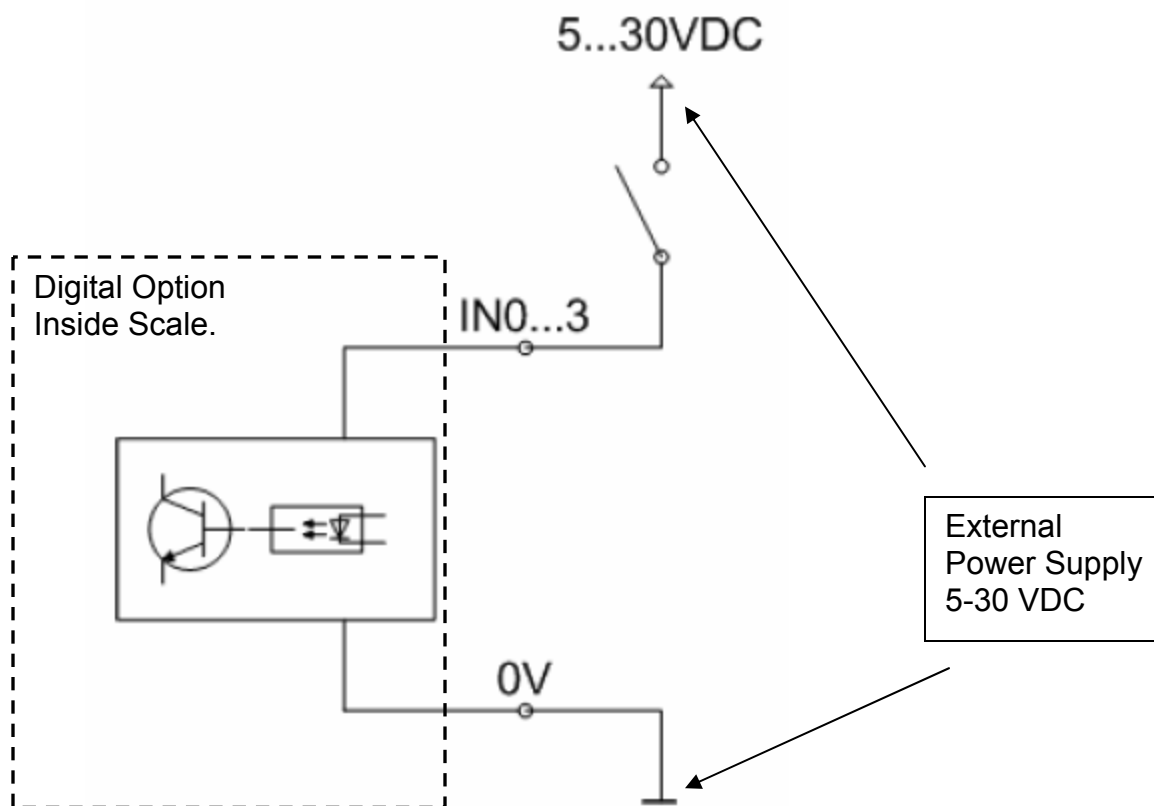

Circuit operation.

The external switch is connected to the + VDC of the external power supply. The switched contact of the external switch is connected to input 0, on pin 6 (INO) of the 9 pin Digital I/O connector. 0 volts of the power supply is connected to pin 1 (GND) of 9 pin Digital I/O connector.

When the switch is closed, electrical current flows through the circuit, energizing the optocoupler inside the Digital I/O board. The optocoupler then turns “on” Input 1 of the option. If the switch is opened the input turns “off”. The inputs are numbered 0 – 3 on the hardware and 1 - 4 in the scale setup menus.

Operation of 4 Series Basic with digital input assigned to “Unit Roll”.

The display is operating in “lb” mode, each time we close the external switch, the scale display changes to units of measure as below.

lb (pounds avoirdupois)
t (metric tons)
g (grams)
kg (kilograms)
oz (ounces avoirdupois)

Hardware installation:

Wire circuit to **pin 6** for input 1 and **pin 1** for 0 volts.

Scale Setup:

Communication / Option / Digital / IN 0 (for hardware input 1) / Unit .

Instead of Unit Roll, we could use: ZERO, TARE, CLEAR, PRINT or OFF (not used).
We have 4 inputs available with the digital option.

Digital I/O-Option (22010184)

Specifications



Control Inputs	4 digital inputs electrically isolated via opto coupler $I_{min} = 1\text{mA} @ U_{min} = 5\text{VDC}$ $I_{max} = 8\text{mA} @ U_{max} = 30\text{VDC}$
Control Outputs	4 digital outputs electrically isolated via opto coupler, open collector $I_{max} = 100\text{mA}, U_{max} = 30\text{VDC}$
Supply Voltage	externally 5...30VDC for control inputs and control outputs
Protection Class	IP65
Connector	female, 9-pin D-SUB 1 0V 2 output OUT 0 3 output OUT 1 4 output OUT 2 5 output OUT 3 6 input IN0 7 input IN1 8 input IN2 9 input IN3
Connection Cable	length 1,5m male, 9-pin D-SUB open cable end with end splice order number 21 254 225 black 0V brown output OUT 0 red output OUT 1 grey output OUT 2 yellow output OUT 3 green input IN0 blue input IN1 violet input IN2 white input IN3
Accessory	Relaisbox 4-ID7 max. switching power 2A/30VDC or 2A/250VAC order number 22 001 088

© METTLER TOLEDO

17.11.2004

End of demo.

Digital I/O: OUTPUT: Basic, Count, Count+, Smart+

The digital I/O option port in the 4-Series provides us with 4 optically isolated inputs and 4 optically isolated outputs. All power is supplied externally.

In this demo we will look at connecting an output to a 4 Series Count+ scale.

The Digital I/O option kit for basic, count and count + is part number 22013142. The option installs inside the scale (or terminal) and field connection is via a 9 pin female connector mounted on the connector plate at the rear of the scale.

In a 4-Series Count+ scale the option is installed as port 2, port 1 remains as RS232. In the Count+ scale we can have one option, so if we choose digital I/O we can not add any further options, such as Ethernet.

The installation of the Digital I/O kit is explained in the installation instructions, 22013616, supplied with the kit. The kit may also be factory installed when ordered together with the scale. See specifications.



Connector plate on rear of scale / terminal.

How does the input circuit work?

The output circuit is optically isolated from the internal circuitry, which means you must provide an external power source. When we connect the external power sourced to the output circuit an optical coupler is energized, turning on the output signal.

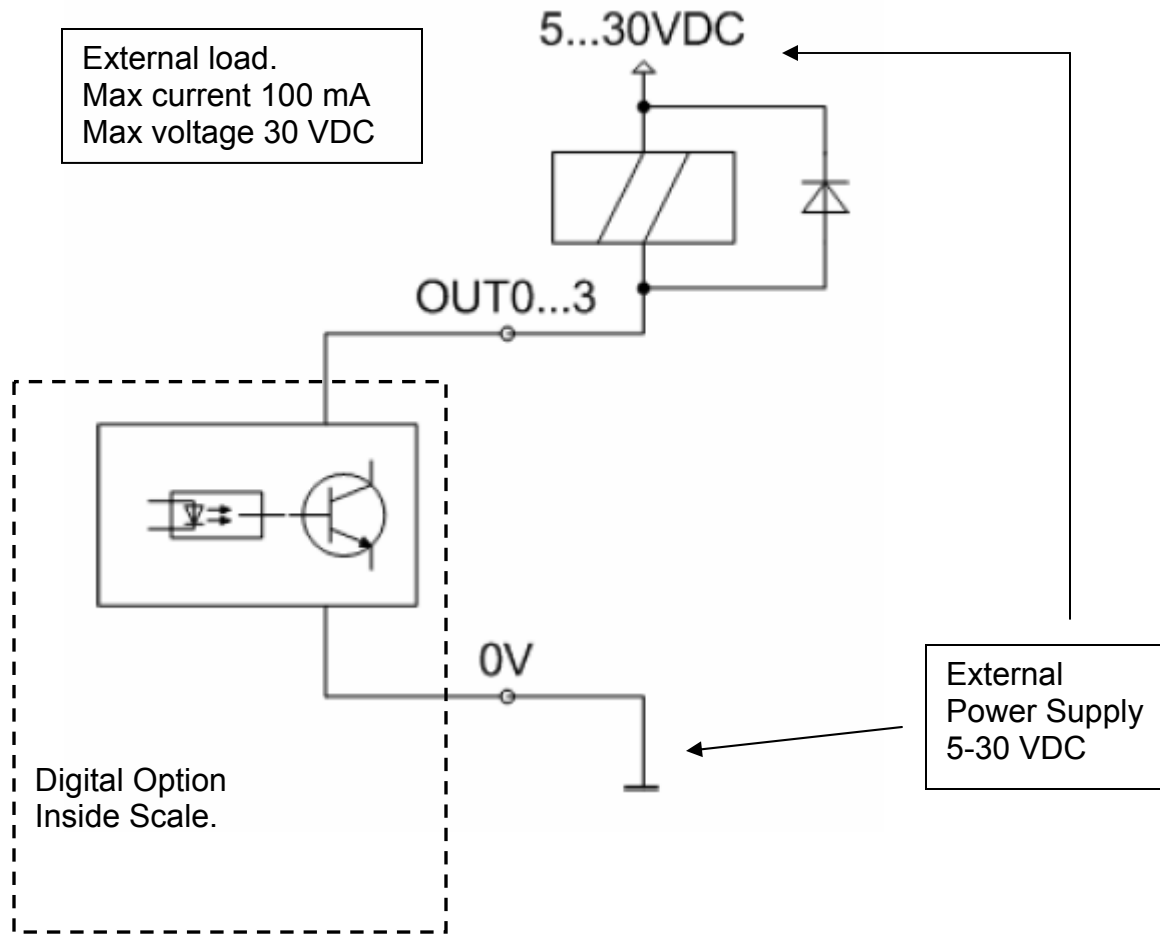

Circuit operation.

The external load, such as a 12 VDC piezo buzzer, is connected to the + VDC of the external power supply. The switched side of the load is connected to output 0, on pin 2 (OUT0) of the 9 pin Digital I/O connector. 0 volts of the power supply is connected to pin 1 (GND) of 9 pin Digital I/O connector.

When the output is turned “on” by the Digital I/O, the optic coupler turns “on” completing the circuit . Electrical current flows through the circuit, energizing the piezo buzzer. The outputs are numbered 0 – 3 on the hardware and 1 - 4 in the scale setup menus.

The voltage drop across the optic coupler is approximately 1 volt. With a 12 volt supply, we would drop 1 volt across the coupler and 11 volts across piezo buzzer. The piezo buzzer we selected for this demo has a maximum current draw of 15 mA, well beneath our limit of 100 mA. For heavier loads such as relay coils, consider using the METTLER TOLEDO Relay 4 I/O as the electrical interface between the 4-Series Digital I/O and the field equipment.

Operation of 4 Series Count+ with digital output 1 assigned to “GOOD”.

The Count+ scale is operating in the +/- Checkweighing mode, when the load on the scale is in the OK zone, the "GOOD" output turns the piezo buzzer "on".

Hardware installation:

Wire circuit to **pin 2** for output 0 and **pin 1** for 0 volts.

Scale Setup:

Application / Checkweighing / Beeper - OFF / Setpt tol – 10 %.

Communication / Option / Digital / Output 1 / Good

Operating in the +/- Checkweighing mode. Setting target / tolerance, we use 1000 grams as target.

Enter 81 and hold the Target button until tArGEt appears in display

Enter 1000 g *, touch the Enter (Print) key

tOLER + will flash in the display

Touch the Enter (Print) key again to enter the tolerance in percentage

Enter 4.0 and touch the Enter (Print) key

tOLER – will flash in the display

Touch the Enter (Print) key again to enter the tolerance in percentage

Enter 4.0 and touch Enter (Print) button

The display goes back to weighing mode with “-“ icon illuminated, indicating that the weight is less than the target. Once the weight passes 50% of the target value, the capacity display at the bottom increases linearly until the lower tolerance is passed. At this point, OK comes onto the display. After the upper tolerance is passed, a solid + appears to indicate the tolerance has been passed.



* Note that the unit of the target is always the defined “display” unit of the scale. If the scale is set up as lb, you cannot change the target to grams during this step. You would first have to change the display to grams, set the target, and then change the scale back to lb. When you switch the units to lb, you must start target/checkweighing again by entering the memory location (81 in this case) and then pressing the Target button briefly. The unit will calculate the target weight and tolerance percentages relative to the new unit selected.



Control Inputs
 4 digital inputs
 electrically isolated via opto coupler
 $I_{min} = 1\text{mA} @ U_{min} = 5\text{VDC}$
 $I_{max} = 8\text{mA} @ U_{max} = 30\text{VDC}$

Control Outputs
 4 digital outputs
 electrically isolated via opto coupler
 open collector
 $I_{max} = 100\text{mA}, U_{max} = 30\text{VDC}$

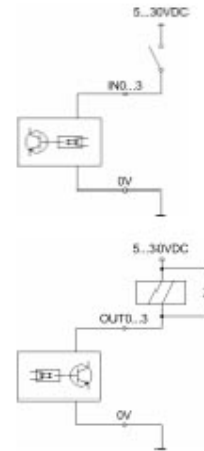

Supply Voltage externally 5...30VDC for control inputs and control outputs

Protection Class IP65

Connector female, 9-pin D-SUB

- 1 0V
- 2 output OUT 0
- 3 output OUT 1
- 4 output OUT 2
- 5 output OUT 3
- 6 input IN0
- 7 input IN1
- 8 input IN2
- 9 input IN3

Connection Cable length 1,5m
 male, 9-pin D-SUB
 open cable end with end splice
 order number 21 254 225

- black 0V
- brown output OUT 0
- red output OUT 1
- grey output OUT 2
- yellow output OUT 3
- green input IN0
- blue input IN1
- violet input IN2
- white input IN3

Accessory Relaisbox 4-ID7
 max. switching power 2A/30VDC or 2A/250VAC
 order number 22 001 088

End of demo.

Digital I/O with Relay 4: Basic, Count, Count+, Smart+

In this demo we will connect a 4-Series Smart+ to Relay 4 I/O for 4 - 24 VDC inputs and 3 - 120 VAC outputs.

Inputs: 24 VDC
C (Clear)
T (Tare)
P (Print)
Z (Zero)

Outputs: 120 VAC
Below Tolerance
Good
Over Tolerance

The Digital I/O option inside the Smart+ has relatively low limits on current and voltage that is why we are using the Relay 4 I/O in this demo. The relay 4 I/O is VDC only for inputs, DC voltage or AC voltage for outputs.

Relay 4 I/O:

INPUTS: 24 VDC, 30 VDC maximum.

OUTPUTS: Maximum 30 VDC, 2 A (DC outputs preferred to extend contact life)
Maximum 250 VAC, 2 A

Block diagram of our demo.

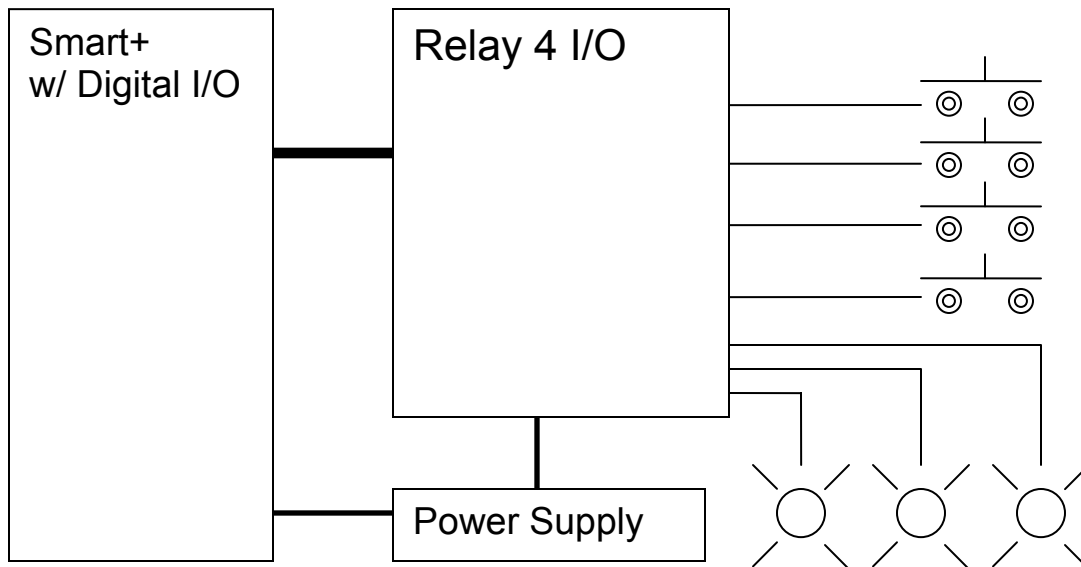

Connection Diagram.

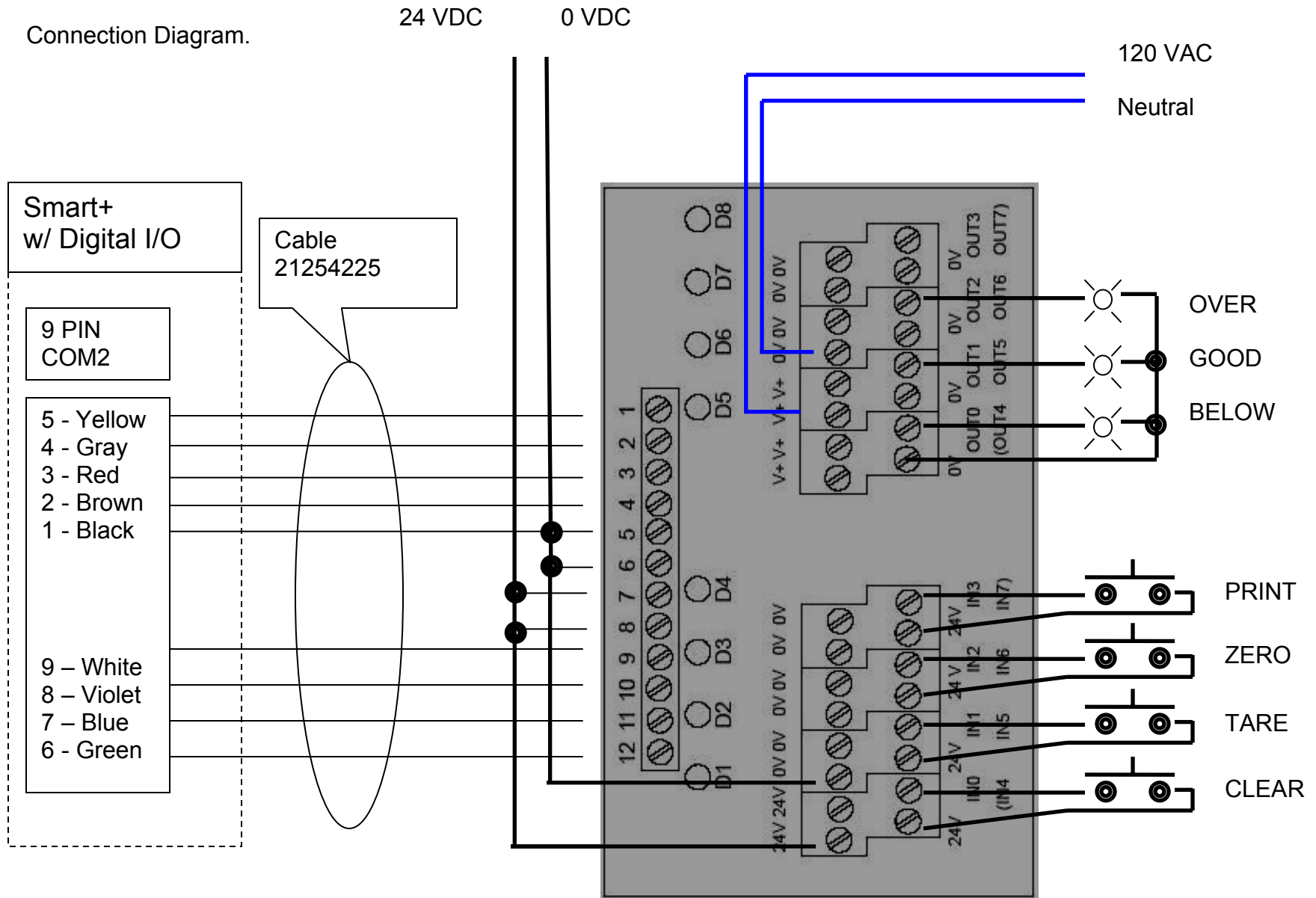

Setup of Smart + for demo.

Define I/O

COMMUNICATIONS / OPTION / DIGITAL I/O / DIGITAL IN 0 / CLEAR
/ DIGITAL IN 1 / TARE
/ DIGITAL IN 2 / ZERO
/ DIGITAL IN 3 / PRINT
/ DIGITAL OUT 0 / < TOL -
/ DIGITAL OUT 1 / GOOD
/ DIGITAL OUT 2 / > TOL +
/ DIGITAL OUT 3 / OFF

Settings for Checkweighing

APPLICATION / FILLING/CHECKWEIGHING / SETPOINT TOL- / 10%

(The digital outputs will not operate unless the scale is loaded to at least 10% of target weight, this prevents nuisance operation of the below, good and over lamps connected to our outputs).

Configure a softkey for Checkweighing.

APPLICATION / SOFTKEYS / SOFTWKEY 6 (or what key you want) /
Checkweighing

Operation of demo.

Touch the Checkweighing softkey to select Checkweighing operation. Load target weight (or count) and tolerances plus and minus. The Output lamps will follow the checkweighing DeltaTrac display. By pressing the buttons you can zero the scale, tare the scale, clear the tare and print. The print key will initiate a printout on all com ports configured as printer. Operation of Checkweighing is not covered in detail here, as this is a demo on setting up digital I/O.

End of demo.

Using Tare Memory: Count +

In many applications, a tare value may be known ahead of time, or perhaps the same tare value is used again and again. For these situations, the 4-Series is capable of storing tare values to be recalled at a later time. This demo illustrates how to save and recall a tare value.

Suppose a carton full of pieces is placed on the scale. The total weight is 20 lb, but the weight of the carton is known to be 1.5 lb. To save this weight as a preset tare value, follow these steps:

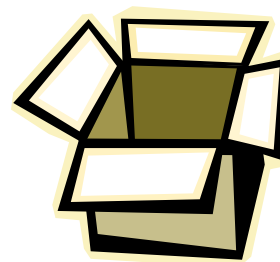

1. First enter the tare weight, 1.5 lb, using the keypad and press TARE. The display will switch to net weight and will show 18.5 lb NET.
2. Next enter the memory location number where the tare weight is to be stored. For this example, the tare weight will be stored in memory location 1. Enter 1 and hold the TARGET  key until TARE.1 appears on the display.

The tare weight of the carton is now stored in memory and will be saved even after the scale is turned off.

An unknown tare weight can also be stored in tare memory as shown by this example:

1. Place an empty carton on the scale. For this example, suppose the display shows 3.2 lb.
2. Press TARE to indicate that this is the tare weight. The display shows 0.0 lb NET.
3. Enter the memory location to store the weight. For example, enter 2 and hold the TARGET  key until TARE.2 appears on the display. The tare weight of the carton is saved.

Now suppose the second carton is filled with parts and placed on the scale. The saved tare value can be recalled in order to find the net weight of the parts.

1. Enter the memory location of the saved tare value (in this example, 2) and press TARGET briefly.
2. The scale briefly displays the saved tare weight, 3.2 lb.
3. The display then shows the net weight of the parts in the carton.

The Count+ has 100 memory locations for storing tare values, average piece weights, target weights, and target quantities. By factory default, locations 1-40 are reserved for tare values. To change the memory partitions, refer to the demo on Checkweighing/Filling by Weight.



End of demo.