



# Table of Contents

<b>1</b>	<b>Introduction</b>	<b>5</b>
<b>2</b>	<b>Safety Measures</b>	<b>6</b>
2.1	Definition of signal warnings and symbols	6
2.2	Product specific safety notes	6
<b>3</b>	<b>Design and Function</b>	<b>9</b>
3.1	Overview	9
3.2	Sensor connections	9
3.3	Keypad	10
3.4	Display and icons	11
3.5	Setup menu navigation	12
3.6	Measurement modes	12
<b>4</b>	<b>Putting into Operation</b>	<b>13</b>
4.1	Scope of delivery	13
4.2	Installing the batteries	13
4.3	Connecting sensors	14
4.4	Installing optional equipment	14
4.4.1	FiveGo™ electrode clip	14
4.4.2	Wrist strap	15
4.5	Switching the instrument on and off	16
<b>5</b>	<b>Operation of the Instrument</b>	<b>17</b>
5.1	General settings	17
5.1.1	Endpoint Formats	17
5.1.2	Temperature capture	17
5.1.3	Barometric pressure	17
5.1.4	Salinity compensation	17
5.1.5	Temperature unit	18
5.2	Performing a calibration	19
5.2.1	Performing a 1-point Calibration	19
5.2.2	Performing a 2-point Calibration	19
5.3	Performing a measurement	19
5.3.1	Measurement mode	19
5.3.2	Performing a DO measurement	20
5.4	Using the memory	20
5.4.1	Storing a measurement result	20
5.4.2	Recalling from memory	20
5.4.3	Clearing the memory	20
5.5	Self-diagnosis	20
5.6	Factory reset	21
<b>6</b>	<b>Maintenance</b>	<b>22</b>
6.1	Cleaning the housing	22
6.2	Electrode maintenance	22
6.3	Error messages	22
6.4	Disposal	23
<b>7</b>	<b>Product Portfolio</b>	<b>24</b>
<b>8</b>	<b>Accessories</b>	<b>25</b>
<b>9</b>	<b>Technical Data</b>	<b>26</b>



## 1 Introduction

Thank you for purchasing this high quality METTLER TOLEDO laboratory meter. With the FiveGo™ portables for pH, conductivity, and DO measurement, we wish to simplify your measuring process and your workflows.

The FiveGo™ portables are much more than just a series portable meters with an excellent price/performance ratio. The meters offer a number of user-friendly features, including

- **Waterproof operation**  
The IP67 waterproof rating that allows free operation in wet or damp environments
- **Optimized ease of use**  
Simple menus for quick and easy operation
- **Excellent ergonomics**  
Handle the instrument with comfort and ease

## 2 Safety Measures

### 2.1 Definition of signal warnings and symbols

Safety notes are marked with signal words and warning symbols. These show safety issues and warnings. Ignoring the safety notes may lead to personal injury, damage to the instrument, malfunctions and false results.

#### Signal words

<b>WARNING</b>	for a hazardous situation with medium risk, possibly resulting in severe injuries or death if not avoided.
<b>CAUTION</b>	for a hazardous situation with low risk, resulting in damage to the device or the property or in loss of data, or minor or medium injuries if not avoided.
<b>Attention</b>	(no symbol) for important information about the product.
<b>Note</b>	(no symbol) for useful information about the product.

#### Warning symbols



General hazard



Toxic substance



Inflammable or explosive substance

### 2.2 Product specific safety notes

Your instrument represents state-of-the-art technology and complies with all recognized safety rules, however, certain hazards may arise in extraneous circumstances. Do not open the housing of the instrument; it does not contain any parts that can be maintained, repaired or replaced by the user. If you experience problems with your instrument, contact your authorized METTLER TOLEDO dealer or service representative.

#### Intended use



This instrument is designed for a wide range of applications in various areas and is suitable for measuring dissolved oxygen.

The use therefore requires knowledge and experience in working with toxic and caustic substances.

The manufacturer shall not be held liable for any damage resulting from incorrect usage divergent to the operating instructions. Furthermore, the manufacturer's technical specifications and limits must be adhered to at all times and in no way exceeded.

#### Location



The instrument has been developed for indoor operation and may not be used in explosive environments.

Use the instrument in a location which is suitable for the operation, protected from direct sunlight and corrosive gases. Avoid powerful vibrations, excessive temperature fluctuations and temperatures below 0 °C and above 40 °C.

After use, place the instrument back in the carrying case to reduce instruments exposure to UV radiation and prolong material quality and appearance.

## Protective Clothing

It is advisable to wear protective clothing in the laboratory when working with hazardous or toxic substances.



A lab coat should be worn.



Suitable eye protection such as goggles should be worn.



Use appropriate gloves when handling chemicals or hazardous substances, checking their integrity before use.

## Safety notes



### **WARNING**

#### **Chemicals**

All relevant safety measures are to be observed when working with chemicals.

- a) Set up the instrument in a well-ventilated location.
- b) Any spills should be wiped off immediately.
- c) When using chemicals and solvents, comply with the instructions of the producer and the general lab safety rules.



### **WARNING**

#### **Flammable solvents**

All relevant safety measures must be observed when working with flammable solvents and chemicals.

- a) Keep all sources of flame away from the workplace.
- b) When using chemicals and solvents, comply with the instructions of the producer and the general lab safety rules.

## **FCC Rules**

This device complies with Part 15 of the FCC Rules and Radio Interference Requirements of the Canadian Department of Communications. Operation is subject to the following conditions: (1) this device may not cause harmful interference, and (2) this device must accept any interference received, including interference that may cause undesired operation.

This equipment has been tested and found to comply with the limits for a Class A digital device, pursuant to Part 15 of the FCC rules. These limits are designed to provide reasonable protection against harmful interference when the equipment is operated in a commercial environment. This equipment generates, uses, and can radiate radio frequency energy and, if not installed and used in accordance with the instruction manual, may cause harmful interference to radio communications. Operation of this equipment in a residential area is likely to cause harmful interference in which case the user will be required to correct the interference at his own expense.



### 3 Design and Function

#### 3.1 Overview

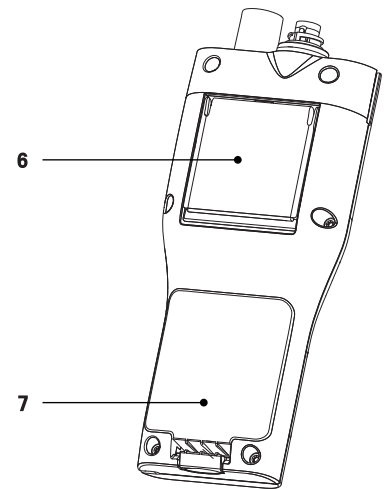
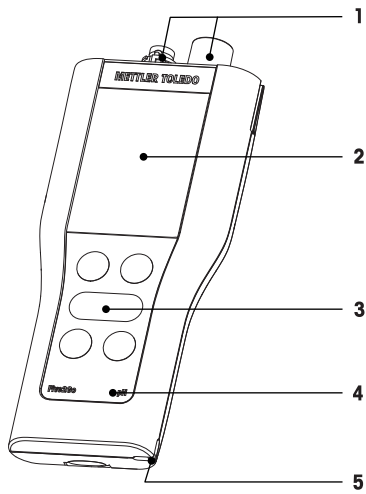

- 1 Sensor connections
- 2 Display
- 3 Keypad
- 4 Type label

- 5 Slot for wrist strap
- 6 Table top stand
- 7 Battery compartment



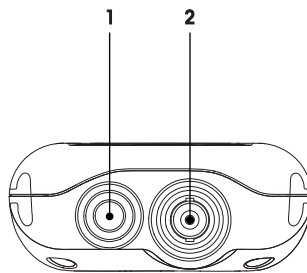

#### 3.2 Sensor connections

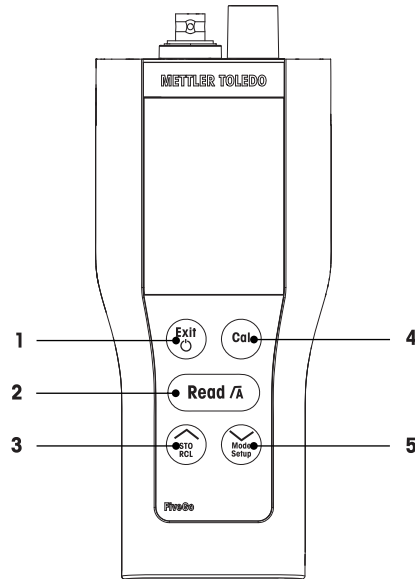

- 1 RCA (Cinch) socket for temperature input
- 2 BNC socket for the dissolved oxygen signal input

### 3.3 Keypad



	Key	Naming	Press and release	Press and hold
1		On / Off / Exit	<ul style="list-style-type: none"> <li>Switch meter on</li> <li>Back to measurement screen</li> </ul>	<ul style="list-style-type: none"> <li>Switch meter off</li> </ul>
2		Read / Endpoint format	<ul style="list-style-type: none"> <li>Start or endpoint measurement</li> <li>Confirm setting</li> </ul>	<ul style="list-style-type: none"> <li>Turn auto endpoint on or off</li> </ul>
3		Store / Recall	<ul style="list-style-type: none"> <li>Store current reading to memory</li> <li>Increase value during setting</li> <li>Scroll up through the memory</li> </ul>	<ul style="list-style-type: none"> <li>Recall stored data</li> </ul>
4		Calibration	<ul style="list-style-type: none"> <li>Start calibration</li> </ul>	<ul style="list-style-type: none"> <li>Recall calibration data</li> </ul>
5		Mode / Setup	<ul style="list-style-type: none"> <li>Decrease value during setting</li> <li>Scroll down through the memory</li> </ul>	<ul style="list-style-type: none"> <li>Enter setup mode</li> </ul>





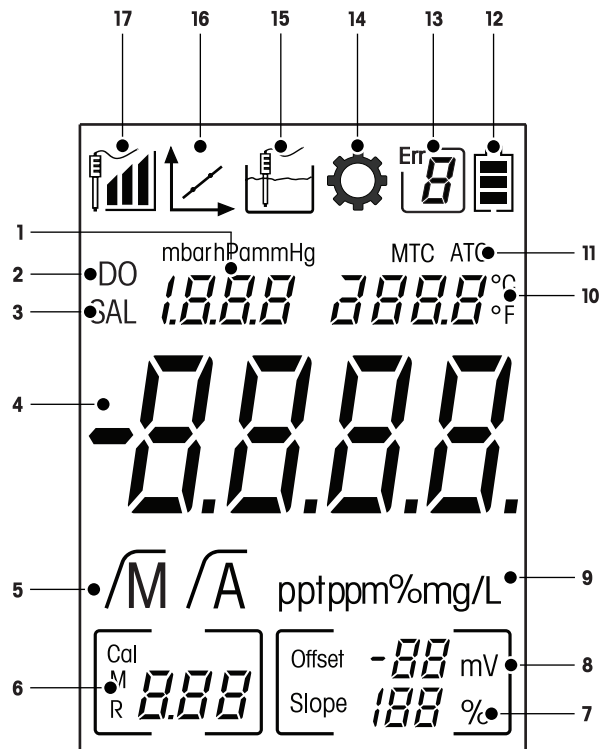

### 3.4 Display and icons

When turning on the instrument, the startup screen appears for 3 seconds. The startup screen shows all icons which can appear on the display. In the following table you find a short description about these icons.

#### Startup screen





	Icon	Description
1	---	Atmospheric pressure display and setting
2	<b>DO</b>	Dissolved oxygen measurement mode
3	<b>SAL</b>	Salinity entry in setup menu
4	---	DO measurement value
5	√M / √A	Endpoint format: √A Automatic √M Manual
6	---	Memory information
7	<b>Slope</b>	Slope and offset are quality indicators for the attached sensor and are determined during calibration
8	<b>Offset</b>	Offset value of sensor
9	<b>ppt / ppm / % / mg/L</b>	Currently used measurement unit
10	---	Temperature information
11	<b>MTC / ATC</b>	<b>MTC</b> (Manual temperature capture) <b>ATC</b> (Automatic temperature capture)
12		Power status <ul style="list-style-type: none"> <li> fully charged</li> <li> half charged</li> <li> lowly charged</li> <li> fully discharged</li> </ul>
13		Error code

	Icon	Description
14		Setup mode
15		Measurement mode
16		Calibration mode: Indicates calibration mode and appears whenever you are performing a calibration or reviewing calibration data.
17		Electrode performance  Slope: 80-125% / Electrode in good condition  Slope: 70-79% / Electrode needs cleaning  Slope: 60-69% / Electrode is faulty

### 3.5 Setup menu navigation

For general navigation in the setup menu read the following information:

- Press and hold **Setup** to enter the setup menu.
- Press **Exit** to exit the setup menu.
- Use  and  do increase or decrease values.
- Press **Read** to confirm a change.

The following parameters can be changed in the order as shown.

Parameter	Description	Range
<b>MTC</b>	Manual temperature setting	0.0...50.0 °C / 32.0...122 °F
<b>Barometric pressure</b>	Barometric pressure entry	375...825 mmHg, 500...1100 mbar 500...1100 hPa
<b>SAL</b>	Salinity entry	0.0...50.0 ppt
<b>°C, °F</b>	Temperature unit	°C, °F

### 3.6 Measurement modes

With the F4 DO meter it is possible to measure the following parameters of a sample:

- ppm
- mg/L
- %

To change the unit, press **Mode** on the measurement screen until the desired appears.

## 4 Putting into Operation

### 4.1 Scope of delivery

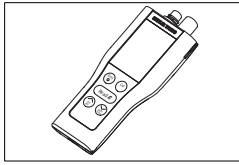

FiveGo™ F4 instrument  
for DO measurement

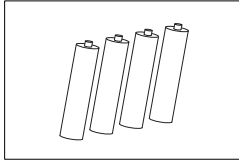

Battery LR03/AAA 1.5V  
4 pcs.

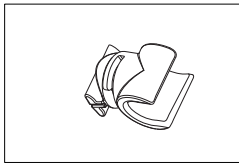

FiveGo™ electrode clip  
1 pc.

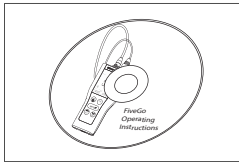

CD-ROM including operating instructions

### 4.2 Installing the batteries

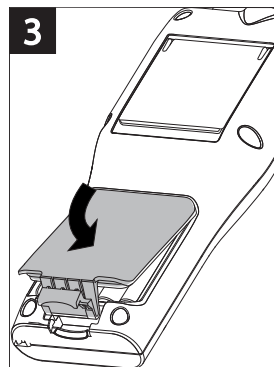
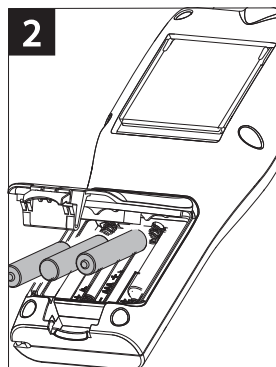
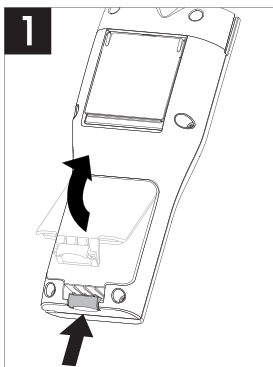

## 4.3 Connecting sensors

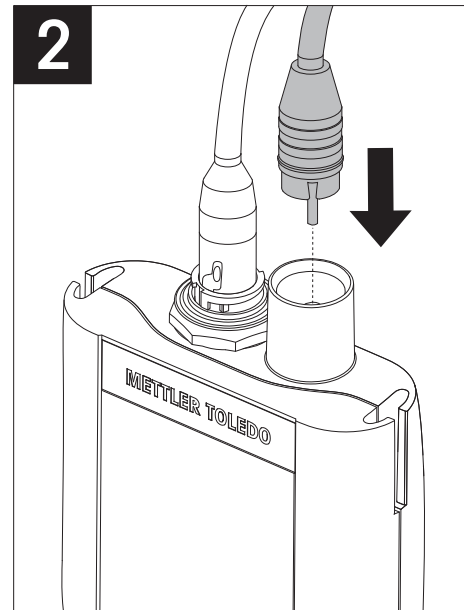
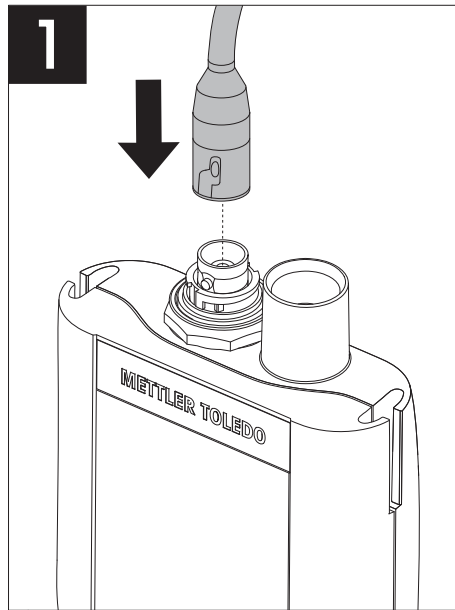

## 4.4 Installing optional equipment

### 4.4.1 FiveGo™ electrode clip

For a safe placing of the electrode you can mount an electrode clip on the side of the instrument. The electrode clip is part of delivery. You can mount it on either sides of the instrument according to your preference.

- Remove the protective clips (1).

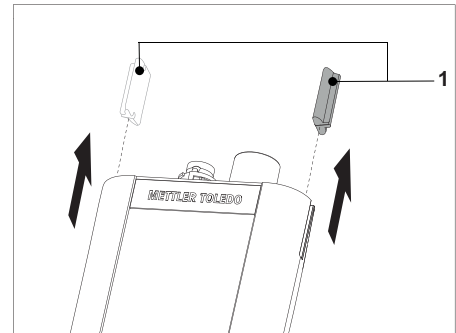

- Push the electrode clip (1) into the recess (2) of the instrument.

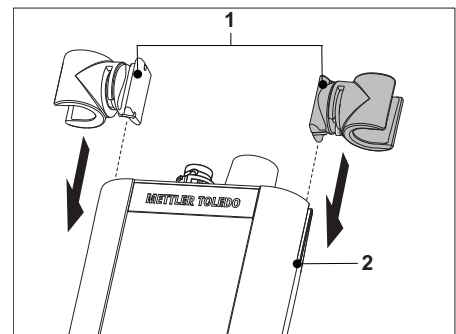

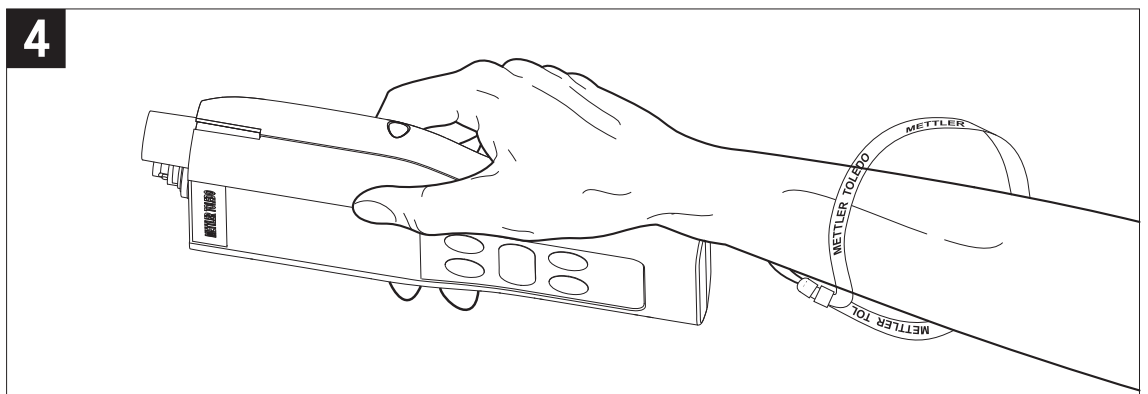
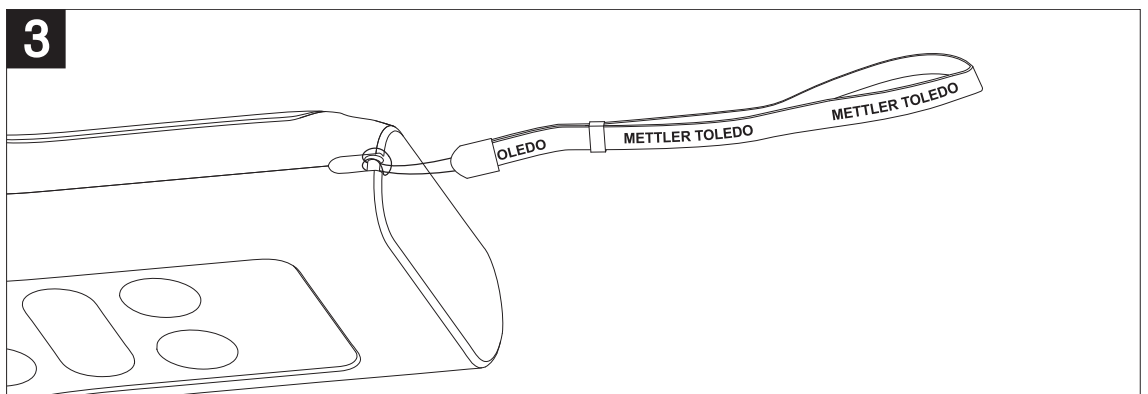
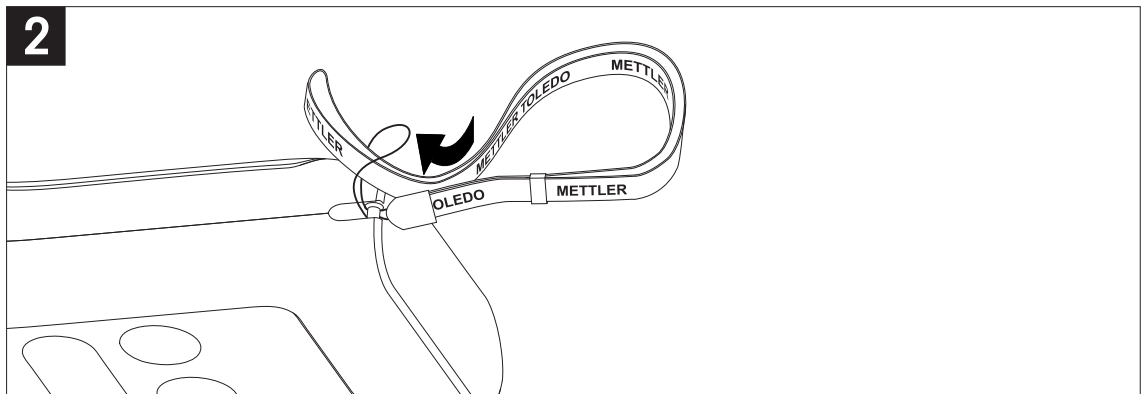
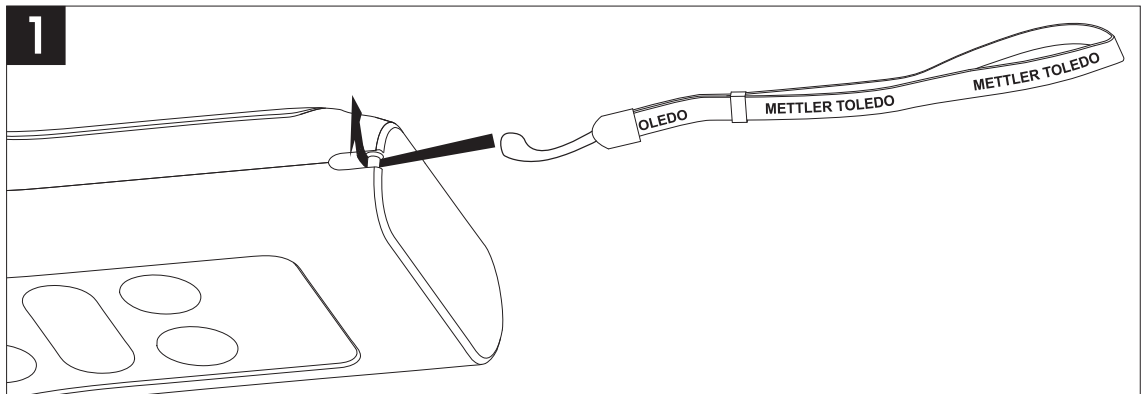

#### 4.4.2 Wrist strap

For better protection against damage caused by dropping, you can mount the wrist strap as shown in the following diagrams.



## 4.5 Switching the instrument on and off

- 1 Press and release  to switch on the instrument.
  - ⇒ All segmented digital numbers and icons are displayed for 3 seconds. After that the installed software version appears (e.g. 1.00) and the instrument is ready for use.
- 2 Press  for 3 seconds and release to switch off the instrument.

### Note

By default after 10 minutes not in use, the instrument shuts down automatically.

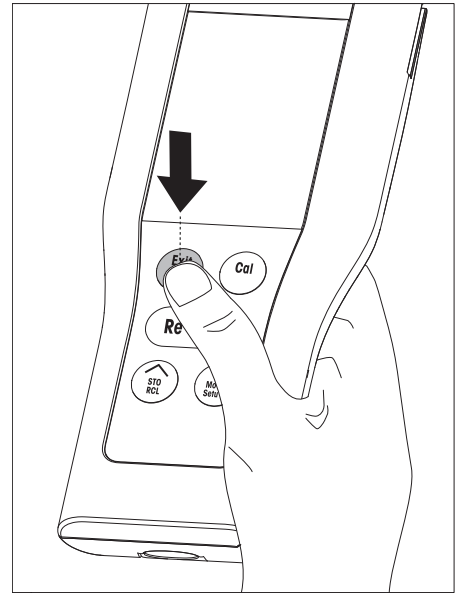



## 5 Operation of the Instrument

### 5.1 General settings

#### 5.1.1 Endpoint Formats

The FiveGo™ offers two different endpoint formats, automatic and manual. To switch between the automatic and manual endpoint modes, press and hold **Read**.

##### Automatic endpoint

With the automatic endpoint, the measurement stops automatically as soon as the input signal is stable. This ensures an easy, quick and precise measurement.

##### Manual endpoint

Unlike the automatic endpoint, user interaction is required to stop the measurement reading in manual mode. To manually endpoint a measurement, press **Read**.

#### 5.1.2 Temperature capture

##### Automatic temperature capture (ATC)



For better accuracy, we recommend the use of either a sensor with a built-in or a separate temperature probe. If a temperature probe is recognized by the meter, **ATC** and the sample temperature are displayed.

##### Note

The meter accepts NTC 30 kΩ temperature sensors.





##### Manual temperature capture (MTC)

If the meter does not detect a temperature probe, it automatically switches to the manual temperature capture mode and **MTC** appears. The entered MTC temperature is used for temperature compensation.



- 1 To set the MTC temperature, press and hold **Setup** .  
⇒ The temperature value is blinking. The default setting is 25 °C.
- 2 Choose the temperature value by using  and .
- 3 Press **Read** to confirm your settings.
- 4 Continue with barometric pressure settings or press **Exit** to return to measurement screen.

#### 5.1.3 Barometric pressure



For calibration and measurements, the actual barometric pressure is very important, since this influences the dissolved oxygen value. Make sure you always enter the correct barometric pressure.

- After confirming the manual temperature setting, the barometric pressure value is blinking. The default setting is 1013.
  - 1 Adjust the value by using  and .
  - 2 Press **Read** to confirm your settings.
  - 3 The barometric pressure unit is blinking. The default setting is mbar.
  - 4 Choose the barometric pressure unit by using  and .
  - 5 Press **Read** to confirm your settings.
  - 6 Continue with salinity setup or press **Exit** to return to measurement screen.

#### 5.1.4 Salinity compensation

- After confirmation of barometric pressure setting, the salinity value is blinking. The default value is 0.0 ppt (parts per thousand).
  - 1 Adjust the value by using  and .
  - 2 Press **Read** to confirm your settings.
  - 3 Continue with Temperature unit or press **Exit** to return to measurement screen.

### 5.1.5 Temperature unit



- After confirming the salinity compensation setting, the temperature unit is blinking.
  - 1 Select the temperature unit (°C or °F) using  and .
  - 2 Press **Read** to confirm and get back to the measurement screen.

## 5.2 Performing a calibration

The FiveGo™ DO meter allows you to run a 1-point or 2-point calibration. The first calibration must be run in air. The second calibration (optional) must be run in a zero-oxygen solution.

A 2-point calibration is recommended if measurements below 10% oxygen saturation or an oxygen concentration below 1 mg/L or 1 ppm are planned. For higher values a 1-point calibration is usually sufficient.



### 5.2.1 Performing a 1-point Calibration

- A sensor is connected to the instrument.
  - Before starting a calibration, make sure that the correct barometric pressure is entered, see Barometric pressure [▶ 17].
- 1 Place the sensor in the air and press **Cal**.
  - 2 Press **Cal**.
    - ⇒  and  appear on the display.  
During measurement the DO value based on the previous calibration is shown. Depending on the endpoint format, the instrument stops measuring when the signal is stable (auto endpoint) or after pressing **Read** (manual endpoint).
    - ⇒ At endpoint  disappears from the display and 100% is shown.
  - 3 If you do not want to proceed with the 2-point calibration, press **Read** to finish the 1-point calibration.
    - or –
    - If you want to reject the 1-point calibration press **Exit** to reject the calibration.
    - or –
    - To proceed with 2-point calibration go to Performing a 2-point Calibration [▶ 19].

#### Note

With the 1-point calibration only the slope is adjusted and theoretical offset (0 mV) will be used.

### 5.2.2 Performing a 2-point Calibration

- Perform the first calibration point as described in the section Performing a 1-point calibration
- 1 Place the sensor in the zero-oxygen solution (see the description below for preparing the solution).
  - 2 Press **Cal**.
    - ⇒  and  appear on the display.  
During measurement the DO value based on the previous calibration is shown. Depending on the endpoint format, the instrument stops measuring when the signal is stable (auto endpoint) or after pressing **Read** (manual endpoint).
    - ⇒ At endpoint  disappears from the display and 0 % is shown.
  - 3 The calibration will be automatically terminated with the calibration result as sensor slope and offset will be shown on the bottom right of the display.

#### Note

With the 2-point calibration, both slope and offset would be updated and shown on the display.

#### Preparing a zero-oxygen solution

A zero-oxygen solution is prepared by dissolving a zero-oxygen tablet in 40 mL of deionized water and stirring for at least 5 minutes (see Accessories [▶ 25] for the order number).

## 5.3 Performing a measurement

### 5.3.1 Measurement mode

The FiveGo™ DO meter offers three different reading modes: %, mg/L and ppm.

- Press the **Mode** button to switch between the modes.

### 5.3.2 Performing a DO measurement

- A sensor is connected to the instrument.
- 1 Place the sensor in the sample and press **Read** to start the measurement.
  - ⇒ The decimal point blinks.
  - ⇒ The display shows the oxygen concentration of the sample.
  - ⇒ If the automatic endpoint is selected, and the signal has stabilized, the display freezes,  $\sqrt{A}$  appears and the decimal point stops blinking. In case the **Read** button was pressed before the automatic stabilization, the display freezes and  $\sqrt{M}$  appears.
- 2 If the manual endpoint is chosen, press **Read** to manually endpoint a measurement. The display freezes and  $\sqrt{M}$  appears.

#### Note

Press and hold **Read** to switch between the automatic and manual endpoint format.

## 5.4 Using the memory

### 5.4.1 Storing a measurement result

The instrument can store up to 200 endpointed results.

- Press **STO** when the measurement has endpointed.
  - ⇒ **M001** indicates that one result has been stored, and **M200** that the maximum of 200 results have been stored.

#### Note

If you press **STO** when **M200** is displayed, **Err 6** indicates that the memory is full. To store further data you will have to clear the memory.

### 5.4.2 Recalling from memory

- 1 Press and hold **RCL** to recall the stored values.
- 2 Press  $\swarrow$  or  $\searrow$  to scroll through the stored results.
  - ⇒ **MR 001** to **MR 200** indicates which result is currently displayed.
- 3 Press **Exit** to go back to the measurement screen.

### 5.4.3 Clearing the memory

- 1 Press and hold **RCL** to recall the stored values from memory.
- 2 Press **RCL** until **ALL** appears on the display.
- 3 Press **Read** to delete all measurement results.
  - ⇒ **CLr** starts blinking on the display.
- 4 Press **Read** to confirm the deletion
  - or -
  - Press **Exit** to cancel the deletion.

## 5.5 Self-diagnosis

- 1 Switch the meter on.
- 2 Press **Read** and **Cal** simultaneously until the meter displays the full screen.
  - ⇒ Each icon blinks one after the other whereby you can check if all icons are correctly shown on the display.
  - ⇒ After that, **b** starts to blink and 5 hardkey-icons are shown on the display.
- 3 Press any hardkey.
  - ⇒ The specific icon disappears from the display.

4 Press each hardkey once.

⇒ When the self-diagnosis is completed successfully, **PAS** appears. If the self-diagnosis has failed, **Err 2** appears.

#### Note

You must press all hardkeys within 1 minute. Otherwise **FAL** appears and the self-diagnosis has to be redone.

## 5.6 Factory reset



### Note

#### Loss of data!

With a factory reset all user-specific settings will be set to standard. Also all data memories will be deleted.

- The instrument is switched off.
- 1 Press and hold **Read**, **Cal** and **Exit** simultaneously for 2 seconds.
  - ⇒ **RST** appears on the display.
- 2 Press **Read**.
- 3 Press **Exit**.
  - ⇒ The instrument switches off.
  - ⇒ All settings are reset.

## 6 Maintenance

### 6.1 Cleaning the housing



#### Note

##### Damage to the instrument!

Ensure that no liquid enters the interior of the instrument.

Wipe off any spills immediately.

The meter does not require any maintenance other than an occasional wipe with a damp cloth. The housing is made of acrylonitrile butadiene styrene (ABS). This material is sensitive to some organic solvents, such as toluene, xylene and methyl ethyl ketone (MEK).

- Clean the housing of the instrument using a cloth dampened with water and a mild detergent.

### 6.2 Electrode maintenance

- The DO sensor measures the oxygen content galvanically: It produces a mV-output proportional to the oxygen concentration present in the medium. Oxygen diffuses through the membrane and is being consumed at the cathode, producing an electric current. Although the amount of oxygen consumed is low, a new sample should still flow past the membrane to prevent false readings.
- For maximum lifetime and maximum accuracy, the sensor should be handled with proper care. After use, rinse the sensor with clean deionized water and wipe with a soft tissue. When storing the sensor for a longer period, make sure it is placed in the wetting cap supplied in the standard delivery. Also deposits on the membrane should be removed with a tissue, because they hamper the diffusion of oxygen through the membrane.

#### Note

The filling solution in the electrode cap is 10% NaCl (Sodium chloride). Cleaning and filling solutions should be handled with the same care as that given to toxic and corrosive substances.

### 6.3 Error messages

Error	Description	Resolution
Err 1	Memory access error	Reset to factory settings
Err 2	Self-diagnosis failed	Repeat the self-diagnosis procedure and make sure that you finish pressing all five keys within two minutes.
Err 3	Measured values out of range	Make sure that the electrode wetting cap has been removed and the electrode is properly connected and placed in the sample solution. If no electrode is connected, put the shorting plug in the socket.
Err 4	Cal. 2 out of range (<-3 mV or >3 mV)	Make sure the electrode is connected and in good condition. Disconnect, clean and replace the electrode.
Err 5	Cal. 1 out of range (<25 mV or >60 mV)	Make sure the electrode is connected and in good condition. Disconnect, clean and replace the electrode.
Err 6	Memory is full	Clear the memory
Err 7	Measurement data cannot be stored twice	---

## 6.4 Disposal

In conformance with the European Directive 2002/96/EC on Waste Electrical and Electronic Equipment (WEEE) this device may not be disposed of in domestic waste. This also applies to countries outside the EU, per their specific requirements.

Please dispose of this product in accordance with local regulations at the collecting point specified for electrical and electronic equipment. If you have any questions, please contact the responsible authority or the distributor from which you purchased this device. Should this device be passed on to other parties (for private or professional use), the content of this regulation must also be related.

Thank you for your contribution to environmental protection.



## 7 Product Portfolio

Meter and Kits	Description	Order No.
F4-Meter	FiveGo™ DO meter without sensor	30266884
F4-Standard	FiveGo™ DO meter standard kit with LE621 IP67 sensor	30266885
F4-Field	FiveGo™ DO meter field kit with LE621 IP67 sensor and carrying case	30266886



## 8 Accessories

<b>Parts</b>	<b>Order No.</b>
FiveGo™ carrying case (incl. 4 sample bottles)	30239142
FiveGo™ electrode clip (1 pc) and electrode clip covers (2 pcs.)	30239144
Wrist strap (METTLER TOLEDO)	30122304
Battery cover	30254145
Table top stand	30254146
Sample bottles (4 pcs.)	30239143
BNC shortening plug	30133643
Zero oxygen tablets	51300140

<b>Sensors</b>	<b>Order No.</b>
LE621 IP67	30266975

## 9 Technical Data

### General

<b>Power requirements</b>	Batteries	4 x LR03/AAA 1.5 V Alkaline - or - 4 x AAA 1.2 V NiMH rechargeable
	Battery life	> 200 h
<b>Dimensions</b>	Height	188 mm
	Width	77 mm
	Depth	33 mm
	Weight (without batteries)	260 g
<b>Display</b>	LCD	3.1" Segmented LCD, b/w
<b>Ambient conditions</b>	Operating temperature	0...40 °C
	Relative humidity	5%...85% (non-condensing) at 31 °C, linearly descending to 50% at 40 °C
	Overvoltage category	Class II
	Pollution degree	2
	Maximum operating altitude	2000 m above sea level
	Range of application	For indoor use
<b>Materials</b>	Housing	ABS
	Window	Polymethyl methacrylate (PMMA)
	IP Protection class	IP67

### Measurement

<b>Parameters</b>	%, mg/L, ppm	
<b>Sensor inputs</b>	mV	BNC
	Temperature	Cinch, NTC 30 kΩ
<b>DO</b>	Measuring range	0.0...400.0%
		0.0...45.0 mg/L
		0.0...45.0 ppm
	Resolution	0.1, 0.01
Limits of error	± 0.01, ± 1%	
<b>Salinity</b>	Range	0.0...50.0 ppt
<b>Barometric pressure</b>	Range	375...825 mm Hg, 500...1100 mbar 500...1100 hPa
	Resolution	1 mm Hg, 1 mbar, 1 hPa, 0.1 ppt
<b>Temperature</b>	Measuring range	0.0...50.0 °C, 32.0...122 °F
	Resolution	0.1 °C
	Limits of error	± 0.3 °C
	ATC/MTC	Yes
<b>Calibration</b>	Calibration points	2, 100% and 0%
<b>Data security / storage</b>	Memory size	200



## To protect your product's future:

METTLER TOLEDO Service assures the quality, measuring accuracy and preservation of value of this product for years to come.

Please request full details about our attractive terms of service.

[www.mt.com/phlab](http://www.mt.com/phlab)

For more information

**Mettler-Toledo AG, Analytical**

CH-8603 Schwerzenbach, Switzerland

Tel. +41 22 567 53 22

Fax +41 22 567 53 23

[www.mt.com](http://www.mt.com)

Subject to technical changes.

© Mettler-Toledo AG 10/2015

30266927B

